

## Operating Manual

# EL 9000 B 2Q

## Electronic DC Load



Stromversorgung

EPS



Attention! This document is only valid for devices with firmwares "KE: 2.31", "HMI: 2.03" and "DR: 1.6.6" or higher.

Doc ID: EL9QEN  
Revision: 02  
Date: 08/2020





# TABLE OF CONTENTS

## 1 GENERAL

1.1	About this document	4
1.1.1	Retention and use	4
1.1.2	Copyright	4
1.1.3	Validity	4
1.1.4	Symbols and warnings	4
1.2	Warranty	4
1.3	Limit of liability	4
1.4	Disposal of equipment	5
1.5	Product key	5
1.6	Intended usage	5
1.7	Safety	6
1.7.1	Safety notices	6
1.7.2	Responsibility of the user	6
1.7.3	Responsibility of the operator	7
1.7.4	User requirements	7
1.7.5	Alarm signals	8
1.8	Technical data	8
1.8.1	Approved operating conditions	8
1.8.2	General technical data	8
1.8.3	Specific technical data	9
1.8.4	Views	13
1.8.5	Control elements	16
1.9	Construction and function	17
1.9.1	General description	17
1.9.2	Block diagram	17
1.9.3	Scope of delivery	18
1.9.4	Accessories	18
1.9.5	The control panel (HMI)	19
1.9.6	USB-Port Type B (Back side)	19
1.9.7	Interface module slot	20
1.9.8	Analog interface	20
1.9.9	“Share” connector	20
1.9.10	“Sense” connector (remote sensing)	21
1.9.11	Master-Slave bus	21

## 2 INSTALLATION & COMMISSIONING

2.1	Transport and storage	22
2.1.1	Transport	22
2.1.2	Packaging	22
2.1.3	Storage	22
2.2	Unpacking and visual check	22
2.3	Installation	22
2.3.1	Safety procedures before installation and use	22
2.3.2	Preparation	23
2.3.3	Installing the device	23
2.3.4	Connection to DC sources	24
2.3.5	Grounding of the DC input	25
2.3.6	Connecting the “Share” bus	25
2.3.7	Connection of remote sensing	25
2.3.8	Connecting the USB ports	26

2.3.9	Installation of an interface module	26
2.3.10	Connecting the analog interface	27
2.3.11	Initial commission	27
2.3.12	Commission after a firmware update or a long period of non-use	27

## 3 OPERATION AND APPLICATION

3.1	Personal safety	28
3.2	Operating modes	28
3.2.1	Voltage regulation / Constant voltage	28
3.2.2	Current regulation / constant current / current limitation	29
3.2.3	Resistance regulation / constant resistance	29
3.2.4	Power regulation / constant power / power limitation	29
3.2.5	Dynamic characteristics and stability criteria	30
3.3	Alarm conditions	31
3.3.1	Power Fail	31
3.3.2	Overtemperature	31
3.3.3	Overvoltage	31
3.3.4	Overcurrent	31
3.3.5	Overpower	31
3.4	Manual operation	32
3.4.1	Powering the device	32
3.4.2	Switching the device off	32
3.4.3	Switching the DC input on or off	32
3.5	Remote control	33
3.5.1	General	33
3.5.2	Remote control via the rear USB port or interface module	33
3.5.3	Remote control via the front USB	34
3.5.4	Remote control via the analog interface (AI)	35
3.6	Alarms and monitoring	39
3.6.1	Definition of terms	39
3.6.2	Device alarm and event handling	39
3.7	Other applications	41
3.7.1	Two quadrants operation (2QO)	41
3.7.2	Series connection	44
3.7.3	Parallel operation in master-slave (MS)	44

## 4 SERVICE AND MAINTENANCE

4.1	Maintenance / cleaning	47
4.2	Fault finding / diagnosis / repair	47
4.2.1	Replacing a defect mains fuse	47
4.2.2	Firmware updates	47

## 5 CONTACT AND SUPPORT

5.1	Repairs	48
5.2	Contact options	48

## 1. General

### 1.1 About this document

#### 1.1.1 Retention and use

This document is to be kept in the vicinity of the equipment for future reference and explanation of the operation of the device. This document is to be delivered and kept with the equipment in case of change of location and/or user.

#### 1.1.2 Copyright

Reprinting, copying, also partially, usage for other purposes as foreseen of this manual are forbidden and breach may lead to legal process.



#### 1.1.3 Validity

This manual is valid for the following equipment, including derived variants.

Model	Article nr.	Model	Article nr.
EL 9080-85 B 2Q	33 200 710	EL 9080-170 B 2Q	33 200 715
EL 9200-35 B 2Q	33 200 711	EL 9200-70 B 2Q	33 200 716
EL 9360-20 B 2Q	33 200 712	EL 9360-40 B 2Q	33 200 717
EL 9500-15 B 2Q	33 200 713	EL 9500-30 B 2Q	33 200 718
EL 9750-10 B 2Q	33 200 714	EL 9750-20 B 2Q	33 200 719

#### 1.1.4 Symbols and warnings

Warning and safety notices as well as general notices in this document are shown in a box with a symbol as follows:

	<b>Symbol for a life threatening danger</b>
	Symbol for general safety notices (instructions and damage protection bans)
	<i>Symbol for general notices</i>

## 1.2 Warranty

EPS Stromversorgung guarantees the functional competence of the device within the stated performance parameters. The warranty period begins with the delivery of free from defects equipment.

Terms of guarantee are included in the general terms and conditions of EPS Stromversorgung.

## 1.3 Limit of liability

All statements and instructions in this manual are based on current norms and regulations, up-to-date technology and our long term knowledge and experience. EPS Stromversorgung accepts no liability for losses due to:

- Usage for purposes other than defined
- Use by untrained personnel
- Rebuilding by the customer
- Technical changes
- Use of non authorized spare parts

The actual delivered device(s) may differ from the explanations and diagrams given here due to latest technical changes or due to customized models with the inclusion of additionally ordered options.

## 1.4 Disposal of equipment

A piece of equipment which is intended for disposal must, according to European laws and regulations (ElektroG, WEEE) be returned to EPS Stromversorgung for scrapping, unless the person operating the piece of equipment or another, delegated person is conducting the disposal. Our equipment falls under these regulations and is accordingly marked with the following symbol:



## 1.5 Product key

Decoding of the product description on the label, using an example:

**EL 9080 - 85 B 2Q zzz**

										Field for identification of installed options and/or special models
										Extra specification: <b>2Q</b> = Two quadrants (designed to work as load module in a two-quadrants operation mode system with a compatible power supply)
										Construction / Version: <b>B</b> = 2nd generation
										Maximum current of the device in Ampere
										Maximum voltage of the device in Volt
										Series : <b>9</b> = Series 9000
										Type identification: <b>EL</b> = Electronic Load

## 1.6 Intended usage

The equipment is intended to be used, if a power supply or battery charger, only as a variable voltage and current source, or, if an electronic load, only as a variable current sink.

Typical application for a power supply is DC supply to any relevant user, for a battery charger the charging of various battery types and for electronic loads the replacement of Ohm resistance by an adjustable DC current sink in order to load relevant voltage and current sources of any type.



- Claims of any sort due to damage caused by non-intended usage will not be accepted.
- All damage caused by non-intended usage is solely the responsibility of the operator.

## 1.7 Safety

### 1.7.1 Safety notices

#### Mortal danger - Hazardous voltage



- **Electrical equipment operation means that some parts will be under dangerous voltage. Therefore all parts under voltage must be covered!**
- **All work on connections must be carried out under zero voltage (input not connected to voltage sources) and may only be performed by qualified and informed persons. Improper actions can cause fatal injury as well as serious material damage.**
- **Never touch cables or connectors directly after unplugging from mains supply as the danger of electric shock remains.**



- The equipment must only be used as intended
- The equipment is only approved for use within the connection limits stated on the product label.
- Do not insert any object, particularly metallic, through the ventilator slots
- Avoid any use of liquids near the equipment. Protect the device from wet, damp and condensation.
- For power supplies and battery chargers: do not connect loads, particularly such with low resistance, to devices under power; sparking may occur which can cause burns as well as damage to the equipment and to the load.
- For electronic loads: do not connect power sources to equipment under power, sparking may occur which can cause burns as well as damage to the equipment and to the source.
- ESD regulations must be applied when plugging interface cards or modules into the relative slot
- Interface cards or modules may only be attached or removed after the device is switched off. It's not necessary to open the device.
- Do not connect external power sources with reversed polarity to DC input or outputs! The equipment will be damaged.
- For power supply devices: avoid where possible connecting external power sources to the DC output, and never those that can generate a higher voltage than the nominal voltage of the device.
- For electronic loads: do not connect a power source to the DC input which can generate a voltage more than 120% of the nominal input voltage of the load. The equipment is not protected against over voltage and may be irreparably damaged.
- Never insert a network cable which is connected to Ethernet or its components into the master-slave socket on the back side of the device!
- Always configure the various protecting features against overcurrent, overpower etc. for sensitive sources to what the currently used application requires

### 1.7.2 Responsibility of the user

The equipment is in industrial operation. Therefore the operators are governed by the legal safety regulations. Alongside the warning and safety notices in this manual the relevant safety, accident prevention and environmental regulations must also be applied. In particular the users of the equipment:

- must be informed of the relevant job safety requirements
- must work to the defined responsibilities for operation, maintenance and cleaning of the equipment
- before starting work must have read and understood the operating manual
- must use the designated and recommended safety equipment.

Furthermore, anyone working with the equipment is responsible for ensuring that the device is at all times technically fit for use.

## 1.7.3 Responsibility of the operator

Operator is any natural or legal person who uses the equipment or delegates the usage to a third party, and is responsible during its usage for the safety of the user, other personnel or third parties.

The equipment is in industrial operation. Therefore the operators are governed by the legal safety regulations. Alongside the warning and safety notices in this manual the relevant safety, accident prevention and environmental regulations must also be applied. In particular the operator has to

- be acquainted with the relevant job safety requirements
- identify other possible dangers arising from the specific usage conditions at the work station via a risk assessment
- introduce the necessary steps in the operating procedures for the local conditions
- regularly check that the operating procedures are current
- update the operating procedures where necessary to reflect changes in regulation, standards or operating conditions.
- define clearly and unambiguously the responsibilities for operation, maintenance and cleaning of the equipment.
- ensure that all employees who use the equipment have read and understood the manual. Furthermore the users are to be regularly schooled in working with the equipment and the possible dangers.
- provide all personnel who work with the equipment with the designated and recommended safety equipment

Furthermore, the operator is responsible for ensuring that the device is at all times technically fit for use.

## 1.7.4 User requirements

Any activity with equipment of this type may only be performed by persons who are able to work correctly and reliably and satisfy the requirements of the job.

- Persons whose reaction capability is negatively influenced by e. g. drugs, alcohol or medication may not operate the equipment.
- Age or job related regulations valid at the operating site must always be applied.



### **Danger for unqualified users**

Improper operation can cause person or object damage. Only persons who have the necessary training, knowledge and experience may use the equipment.

**Delegated persons** are those who have been properly and demonstrably instructed in their tasks and the attendant dangers.

**Qualified persons** are those who are able through training, knowledge and experience as well as knowledge of the specific details to carry out all the required tasks, identify dangers and avoid personal and other risks.

## 1.7.5 Alarm signals

Alarm conditions, not danger situations, are signalled on the front of this device in form of a red LED “**Error**” (also see section 1.8.4.). The LED collects all of the below listed alarm situations. If there is supervision of the slave units being used, alarms can be decoded by querying a status from the device via any of the digital interfaces. When using to analog interface to monitor the device, only a few major alarm can be decoded. For details see 3.5.4.4.

Global meaning of alarm situation as indicated by LED “Error”:

Signal <b>OT</b> (OverTemperature)	<ul style="list-style-type: none"> <li>• Overheating of the device</li> <li>• DC input will be switched off</li> <li>• Non-critical</li> </ul>
Signal <b>OVP</b> (OverVoltage)	<ul style="list-style-type: none"> <li>• Overvoltage shutdown of the DC input occurs due to high voltage entering the device</li> <li>• Critical! The device and/or the source could be damaged</li> </ul>
Signal <b>OCP</b> (OverCurrent)	<ul style="list-style-type: none"> <li>• Shutdown of the DC input due to excess of the preset limit</li> <li>• Non-critical, protects the source from excessive current drain</li> </ul>
Signal <b>OPP</b> (OverPower)	<ul style="list-style-type: none"> <li>• Shutdown of the DC input due to excess of the preset limit</li> <li>• Non-critical, protects the source from excessive power drain</li> </ul>
Signal <b>PF</b> (Power Fail)	<ul style="list-style-type: none"> <li>• DC input shutdown due to AC undervoltage or internal auxiliary supply defect</li> <li>• Critical on AC overvoltage! AC mains input circuit could be damaged</li> </ul>

## 1.8 Technical data

### 1.8.1 Approved operating conditions

- Use only inside dry buildings
- Ambient temperature 0-50 °C (32...122 °F)
- Operational altitude: max. 2000 m (6500 ft) above sea level
- Maximum 80% humidity, not condensing

### 1.8.2 General technical data

Indication: 6x LEDs

Controls: 1 pushbutton

The nominal values for the device determine the maximum adjustable ranges.



## 1.8.3 Specific technical data

Up to 1200 W	Model 2Q				
	EL 9080-85 B	EL 9200-35 B	EL 9360-20 B	EL 9500-15 B	EL 9750-10 B
<b>AC supply</b>					
Voltage / Frequency	230 V, $\pm 10\%$ (90...264 V), 45...65 Hz				
Connection type	Wall socket				
Fuse	T 6.3 A				
Power consumption	Max. 45 W				
Leak current	< 3.5 mA				
Inrush current @ 230 V	$\approx 23$ A				
<b>DC Input</b>					
Max. input voltage $U_{Max}$	80 V	200 V	360 V	500 V	750 V
Input power $P_{Max}^{(2)}$	1200 W	1000 W	900 W	600 W	600 W
Max. input current $I_{Max}$	85 A	35 A	20 A	15 A	10 A
Overvoltage protection range	$0...1.03 * U_{Max}$	$0...1.03 * U_{Max}$	$0...1.03 * U_{Max}$	$0...1.03 * U_{Max}$	$0...1.03 * U_{Max}$
Overcurrent protection range	$0...1.1 * I_{Max}$	$0...1.1 * I_{Max}$	$0...1.1 * I_{Max}$	$0...1.1 * I_{Max}$	$0...1.1 * I_{Max}$
Overpower protection range	$0...1.1 * P_{Peak}$	$0...1.1 * P_{Peak}$	$0...1.1 * P_{Peak}$	$0...1.1 * P_{Peak}$	$0...1.1 * P_{Peak}$
Max. allowed input voltage	88 V	220 V	396 V	550 V	825 V
Min. input voltage for $I_{Max}$	Approx. 2.2 V	Approx. 2 V	Approx. 2 V	Approx. 6.5 V	Approx. 5.5 V
Temperature coefficient for set values $\Delta / K$	Voltage / current: 30 ppm				
<b>Voltage regulation</b>					
Adjustment range	0...81.6 V	0...204 V	0...367.2 V	0...510 V	0...765 V
Stability at $\Delta I$	< 0.05% $U_{Max}$	< 0.05% $U_{Max}$	< 0.05% $U_{Max}$	< 0.05% $U_{Max}$	< 0.05% $U_{Max}$
Accuracy <sup>(1)</sup> (at 23 $\pm$ 5°C / 73 $\pm$ 9°F)	$\leq 0.1\% U_{Max}$	$\leq 0.1\% U_{Max}$	$\leq 0.1\% U_{Max}$	$\leq 0.1\% U_{Max}$	$\leq 0.1\% U_{Max}$
Remote sensing compensation	Max. 5% $U_{Max}$				
<b>Current regulation</b>					
Adjustment range	0...86.7 A	0...35.7 A	0...20.4 A	0...15.3 A	0...10.2 A
Stability at $\Delta U$	< 0.1% $I_{Max}$	< 0.1% $I_{Max}$	< 0.1% $I_{Max}$	< 0.1% $I_{Max}$	< 0.1% $I_{Max}$
Accuracy <sup>(1)</sup> (at 23 $\pm$ 5°C / 73 $\pm$ 9°F)	$\leq 0.2\% I_{Max}$	$\leq 0.2\% I_{Max}$	$\leq 0.2\% I_{Max}$	$\leq 0.2\% I_{Max}$	$\leq 0.2\% I_{Max}$
Rise time 10...90% $I_{Nom}$	< 23 $\mu$ s	< 40 $\mu$ s	< 24 $\mu$ s	< 22 $\mu$ s	< 18 $\mu$ s
Fall time 90...10% $I_{Nom}$	< 46 $\mu$ s	< 42 $\mu$ s	< 38 $\mu$ s	< 29 $\mu$ s	< 40 $\mu$ s
<b>Power regulation</b>					
Adjustment range	$0...1.02 * P_{Max}$	$0...1.02 * P_{Max}$	$0...1.02 * P_{Max}$	$0...1.02 * P_{Max}$	$0...1.02 * P_{Max}$
Accuracy <sup>(1)</sup> (at 23 $\pm$ 5°C / 73 $\pm$ 9°F)	< 0.5% $P_{Max}$	< 0.5% $P_{Max}$	< 0.5% $P_{Max}$	< 0.5% $P_{Max}$	< 0.5% $P_{Max}$
<b>Resistance regulation</b>					
Adjustment range	0.08...30.6 $\Omega$	0.44...204 $\Omega$	1.4...612 $\Omega$	2.5...1224 $\Omega$	6...2550 $\Omega$
Accuracy <sup>(1)</sup> (at 23 $\pm$ 5°C / 73 $\pm$ 9°F)	$\leq 1\%$ of maximum resistance + 0.3% of maximum current				
<b>Analog interface <sup>(3)</sup></b>					
Set value inputs	U, I, P, R				
Actual value output	U, I				
Control signals	DC on/off, remote control on/off, resistance mode on/off				
Status signals	CV, OVP, OT, OPP, OCP, PF, DC status				

(1 In relation to a rated values, the accuracy defines the maximum deviation between a set value and the corresponding value on the DC input

(2 Up to 30°C ambient temperature, but less above this point and with continuous derating

(3 For technical specifications of the analog interface see „3.5.4.4 Analog interface specification“ on page 36

Up to 1200 W	Model 2Q				
	EL 9080-85 B	EL 9200-35 B	EL 9360-20 B	EL 9500-15 B	EL 9750-10 B
<b>Insulation</b>					
Input (DC) to enclosure	DC minus: permanent max. $\pm 400$ V DC plus: permanent max. $\pm 400$ V + max. input voltage				
Input (AC) to input (DC)	Max. 2500 V, short-term				
<b>Environment</b>					
Cooling	Temperature controlled fans				
Ambient temperature	0...50 °C (32...122 °F)				
Storage temperature	-20...70 °C (-4...158 °F)				
<b>Digital interfaces</b>					
Featured	2x USB-B for communication and service, 1x Master-slave bus				
Slot for digital modules	CAN, CANopen, Profibus, Profinet, RS232, Ethernet, ModBus TCP, EtherCAT				
<b>Terminals</b>					
Rear side	Share Bus, DC input, AC input, remote sensing, analog interface, USB-B, master-slave bus, interface module slot				
Front side	USB-B				
<b>Dimensions</b>					
Enclosure (WxHxD)	19" x 2U x 464 mm (18.2")				
Total (WxHxD)	483 mm x 88 mm x 538 mm (19" x 3.5" x 21.2")				
<b>Standards</b>	EN 61010-1:2011-07, IEC 61000-6-2:2005, IEC 61000-6-3:2006				
<b>Weight</b>	≈9 kg (≈20 lbs)	≈9 kg (≈20 lbs)	≈9 kg (≈20 lbs)	≈9 kg (≈20 lbs)	≈9 kg (≈20 lbs)
<b>Article number</b>	33200710	33200711	33200712	33200713	33200714

Up to 2400 W	Model 2Q				
	EL 9080-170 B	EL 9200-70 B	EL 9360-40 B	EL 9500-30 B	EL 9750-20 B
<b>AC supply</b>					
Voltage / Frequency	230 V, ±10% (90...264 V), 45...65 Hz				
Connection type	Wall socket				
Fuse	T 6.3 A				
Power consumption	Max. 90 W				
Leak current	< 3.5 mA				
Inrush current @ 230 V	≈ 46 A				
<b>DC Input</b>					
Max. input voltage $U_{Max}$	80 V	200 V	360 V	500 V	750 V
Input power $P_{Max}^{(2)}$	2400 W	2000 W	1800 W	1200 W	1200 W
Max. input current $I_{Max}$	170 A	70 A	40 A	30 A	20 A
Overvoltage protection range	$0...1.03 * U_{Max}$	$0...1.03 * U_{Max}$	$0...1.03 * U_{Max}$	$0...1.03 * U_{Max}$	$0...1.03 * U_{Max}$
Overcurrent protection range	$0...1.1 * I_{Max}$	$0...1.1 * I_{Max}$	$0...1.1 * I_{Max}$	$0...1.1 * I_{Max}$	$0...1.1 * I_{Max}$
Overpower protection range	$0...1.1 * P_{Peak}$	$0...1.1 * P_{Peak}$	$0...1.1 * P_{Peak}$	$0...1.1 * P_{Peak}$	$0...1.1 * P_{Peak}$
Max. allowed input voltage	88 V	220 V	396 V	550 V	825 V
Min. input voltage for $I_{Max}$	Approx. 2.2 V	Approx. 2 V	Approx. 2 V	Approx. 6.5 V	Approx. 5.5 V
Temperature coefficient for set values $\Delta / K$	Voltage / current: 30 ppm				
<b>Voltage regulation</b>					
Adjustment range	0...81.6 V	0...204 V	0...367.2 V	0...510 V	0...765 V
Stability at $\Delta I$	< 0.05% $U_{Max}$	< 0.05% $U_{Max}$	< 0.05% $U_{Max}$	< 0.05% $U_{Max}$	< 0.05% $U_{Max}$
Accuracy <sup>(1)</sup> (at 23±5°C / 73±9°F)	≤ 0.1% $U_{Max}$	≤ 0.1% $U_{Max}$	≤ 0.1% $U_{Max}$	≤ 0.1% $U_{Max}$	≤ 0.1% $U_{Max}$
Remote sensing compensation	Max. 5% $U_{Max}$				
<b>Current regulation</b>					
Adjustment range	0...173.4 A	0...71.4 A	0...40.8 A	0...30.6 A	0...20.4 A
Stability at $\Delta U$	< 0.1% $I_{Max}$	< 0.1% $I_{Max}$	< 0.1% $I_{Max}$	< 0.1% $I_{Max}$	< 0.1% $I_{Max}$
Accuracy <sup>(1)</sup> (at 23±5°C / 73±9°F)	≤ 0.2% $I_{Max}$	≤ 0.2% $I_{Max}$	≤ 0.2% $I_{Max}$	≤ 0.2% $I_{Max}$	≤ 0.2% $I_{Max}$
Rise time 10...90% $I_{Nom}$	< 23 μs	< 40 μs	< 24 μs	< 22 μs	< 18 μs
Fall time 90...10% $I_{Nom}$	< 46 μs	< 42 μs	< 38 μs	< 29 μs	< 40 μs
<b>Power regulation</b>					
Adjustment range	$0...1.02 * P_{Max}$	$0...1.02 * P_{Max}$	$0...1.02 * P_{Max}$	$0...1.02 * P_{Max}$	$0...1.02 * P_{Max}$
Accuracy <sup>(1)</sup> (at 23±5°C / 73±9°F)	< 0.5% $P_{Max}$	< 0.5% $P_{Max}$	< 0.5% $P_{Max}$	< 0.5% $P_{Max}$	< 0.5% $P_{Max}$
<b>Resistance regulation</b>					
Adjustment range	0.04...15.3 Ω	0.22...102 Ω	0.7...306 Ω	1.25...612 Ω	3...1275 Ω
Accuracy <sup>(1)</sup> (at 23±5°C / 73±9°F)	≤1% of maximum resistance + 0.3% of maximum current				
<b>Analog interface <sup>(3)</sup></b>					
Set value inputs	U, I, P, R				
Actual value output	U, I				
Control signals	DC on/off, remote control on/off, resistance mode on/off				
Status signals	CV, OVP, OT, OPP, OCP, PF, DC status				

(1 In relation to a rated values, the accuracy defines the maximum deviation between a set value and the corresponding value on the DC input

(2 Up to 30°C ambient temperature, but less above this point and with continuous derating

(3 For technical specifications of the analog interface see „3.5.4.4 Analog interface specification“ on page 36

<b>Up to 2400 W</b>	<i>Model 2Q</i>				
	<i>EL 9080-170 B</i>	<i>EL 9200-70 B</i>	<i>EL 9360-40 B</i>	<i>EL 9500-30 B</i>	<i>EL 9750-20 B</i>
<b>Insulation</b>					
Input (DC) to enclosure	DC minus: permanent max. $\pm 400$ V DC plus: permanent max. $\pm 400$ V + max. input voltage				
Input (AC) to input (DC)	Max. 2500 V, short-term				
<b>Environment</b>					
Cooling	Temperature controlled fans				
Ambient temperature	0...50 °C (32...122 °F)				
Storage temperature	-20...70 °C (-4...158 °F)				
<b>Digital interfaces</b>					
Featured	2x USB-B for communication and service, 1x Master-slave bus				
Slot for digital modules	CAN, CANopen, Profibus, Profinet, RS232, Ethernet, ModBus TCP, EtherCAT				
<b>Terminals</b>					
Rear side	Share Bus, DC input, AC input, remote sensing, analog interface, USB-B, master-slave bus, interface module slot				
Front side	USB-A				
<b>Dimensions</b>					
Enclosure (WxHxD)	19" x 2U x 464 mm (18.2")				
Total (WxHxD)	483 mm x 88 mm x 538 mm (19" x 3.5" x 21.2")				
<b>Standards</b>	EN 61010-1:2011-07, IEC 61000-6-2:2005, IEC 61000-6-3:2006				
<b>Weight</b>	≈11 kg (≈24 lbs)	≈11 kg (≈24 lbs)	≈11 kg (≈24 lbs)	≈11 kg (≈24 lbs)	≈11 kg (≈24 lbs)
<b>Article number</b>	33200715	33200716	33200717	33200718	33200719

1.8.4 Views

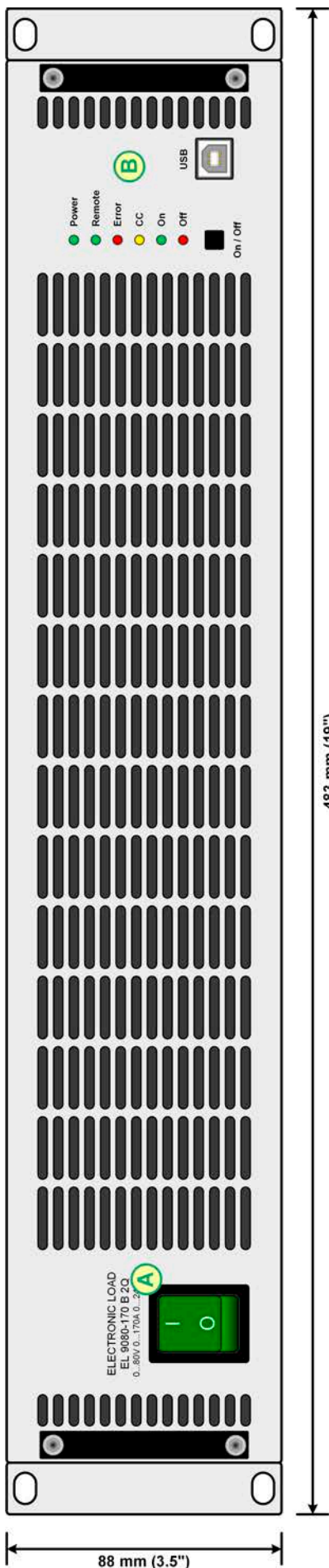

Figure 1 - Front view

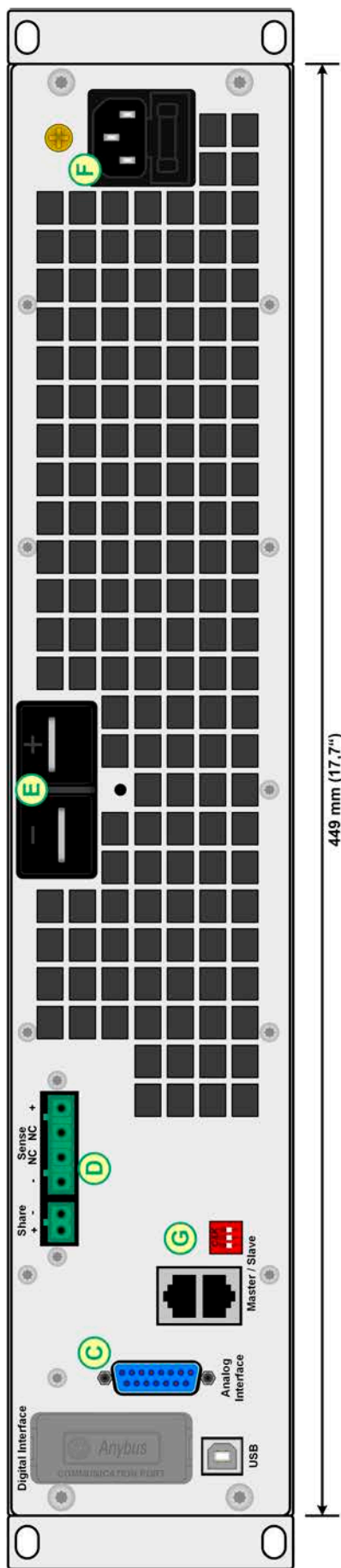

Figure 2 - Rear view

 Do not loosen the grounding point (brass screw above the AC inlet) in order to connect PE cables! The device is supposed to be grounded via the AC cord, while the grounding point is used to connect the enclosure to PE.

- A - Power switch
- B - Control panel
- C - Control interfaces (digital, analog)
- D - Share Bus and remote sensing connection
- E - DC input (screw terminal for M6 screws)
- F - AC socket
- G - Master-Slave ports

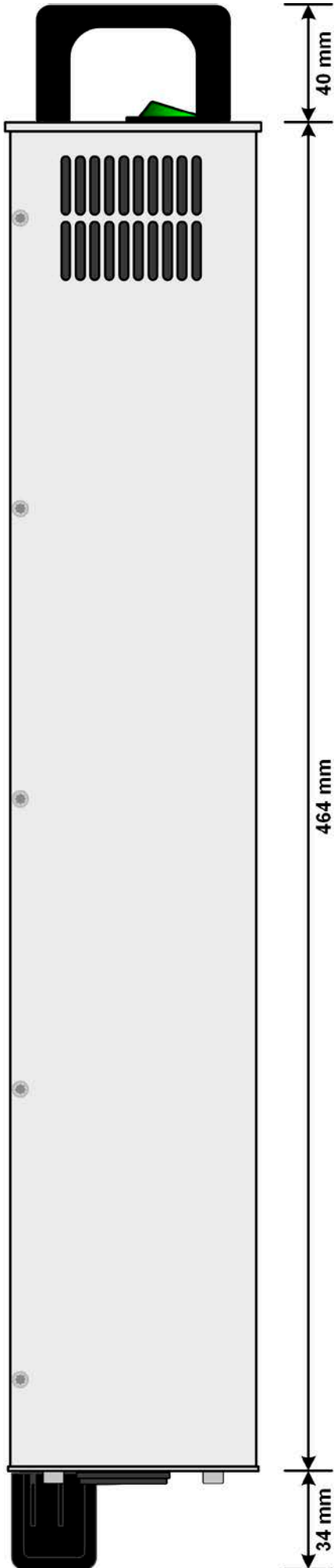

Figure 3 - Left hand side, with DC cover

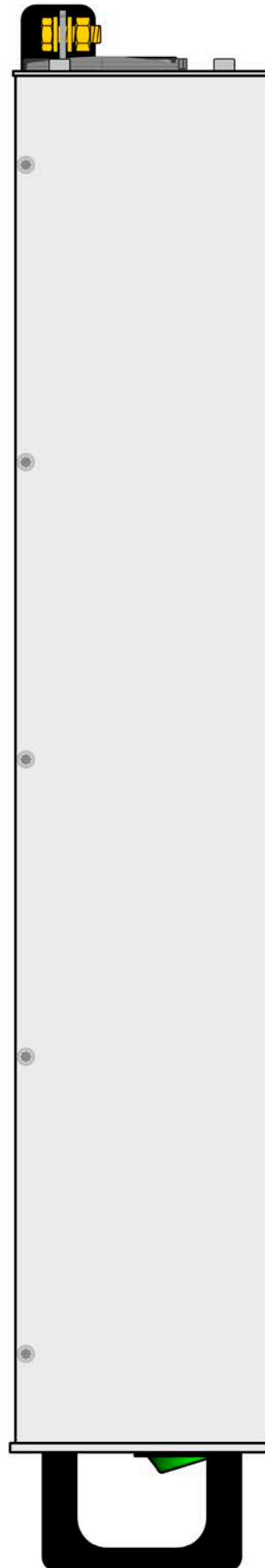

Figure 4 - Right hand side, without DC cover

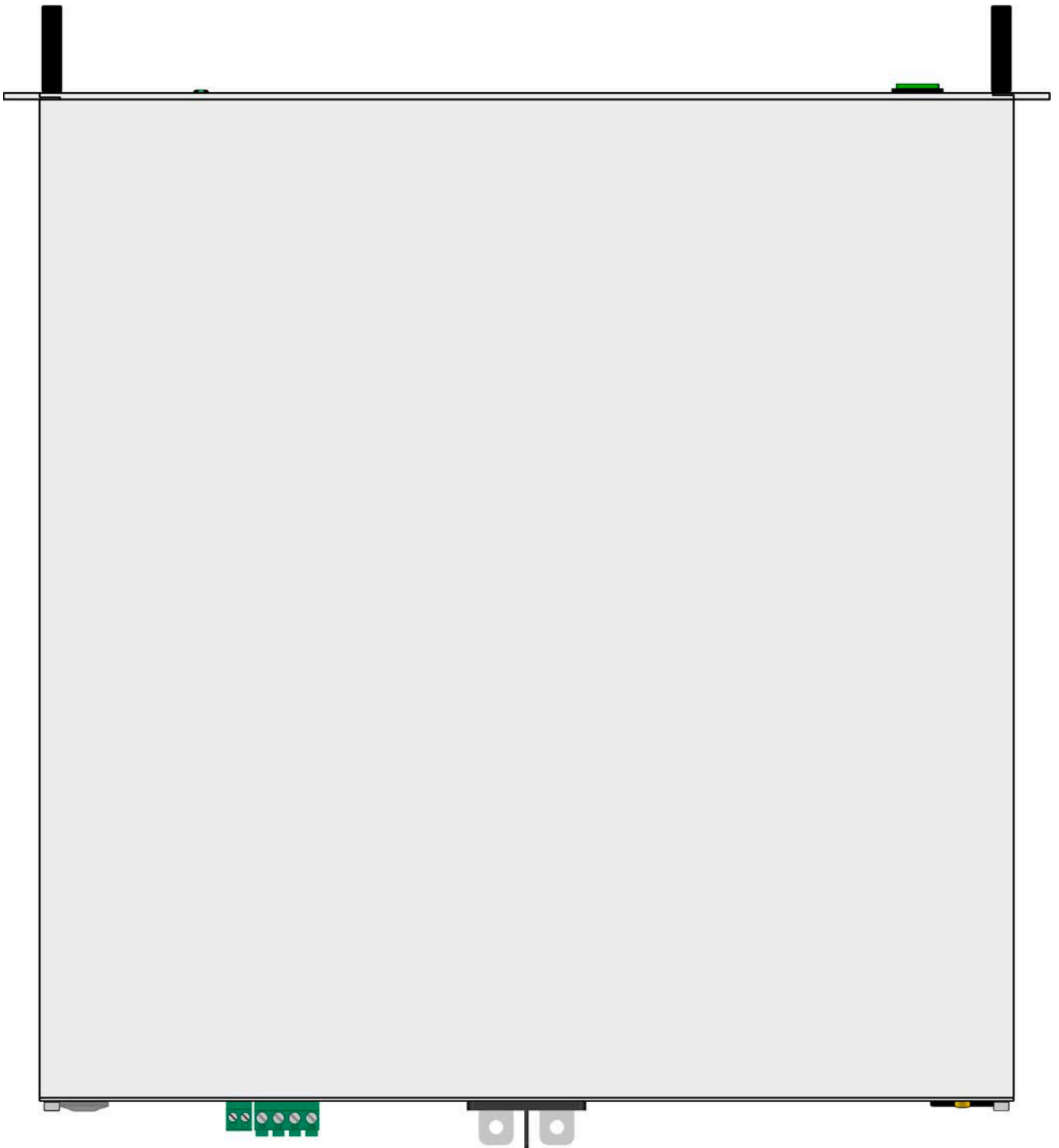

Figure 5 - Top view

1.8.5 Control elements

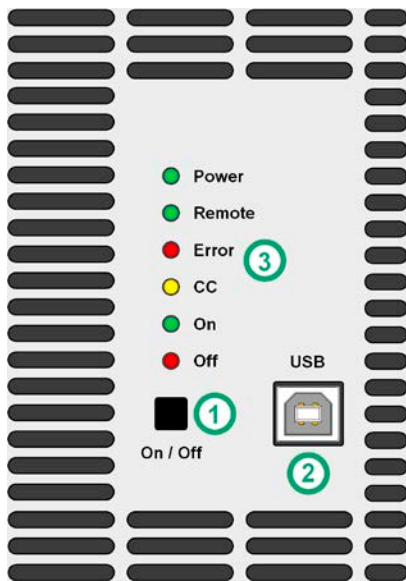

Figure 6 - Control Panel

**Overview of the elements on the control panel**

For a detailed description see section „1.9.5. The control panel (HMI)“.

(1)	<p><b>On/Off button</b> Can be used to switch the DC input on or off during manual operation and while LED “Remote” is off</p>
(2)	<p><b>USB port</b> For quick and easy access to the most important DC input related values when the device is not in master-slave mode. This port has reduced functionality compared to the rear port.</p>
(3)	<p><b>Status indicators (LED)</b> These six color LEDs show the device status. For details refer to 1.9.5.</p>



## 1.9 Construction and function

### 1.9.1 General description

The 2Q in the series name EL 9000 B 2Q stands for “two-quadrants” and points to the main purpose of these devices which is to run as electronic load in a so-called two-quadrants system while being controlled by a power supply unit. Both together build what is also known as an application of the source-sink principle. Such a system is primarily used to test electric and electronic components which can be sources of energy themselves, such as batteries or motors.

As a secondary purpose these devices can be used as slave units with all models from EL 9000 B HP series to build a master-slave system with increased total power of up to 38.4 kW. Depending on the requirement, up to 15 units of 2Q devices can be connected and controlled by one master unit of EL 9000 B HP series.

Apart from basic functions of electronic loads, set point curves can be generated in the integrated function generator (sine, rectangular, triangular and other curve types).

For remote control using a PC or PLC the devices are provided as standard with an USB-B slot on the back side as well as a galvanically isolated analog interface. The USB port on the front serves for quick access to settings and for configuration.

Via optional plug-in interface modules other digital interfaces such as Profibus, ProfiNet, ModBus TCP, CANopen, CAN and more can be added. These enable the devices to be connected to standard industrial buses simply by changing or adding a small module. The configuration of the device and the interface is done via software from a PC.

### 1.9.2 Block diagram

The block diagram illustrates the main components inside the device and their relationships.

There are digital, microprocessor controlled components (KE, DR, HMI), which can be target of firmware updates.

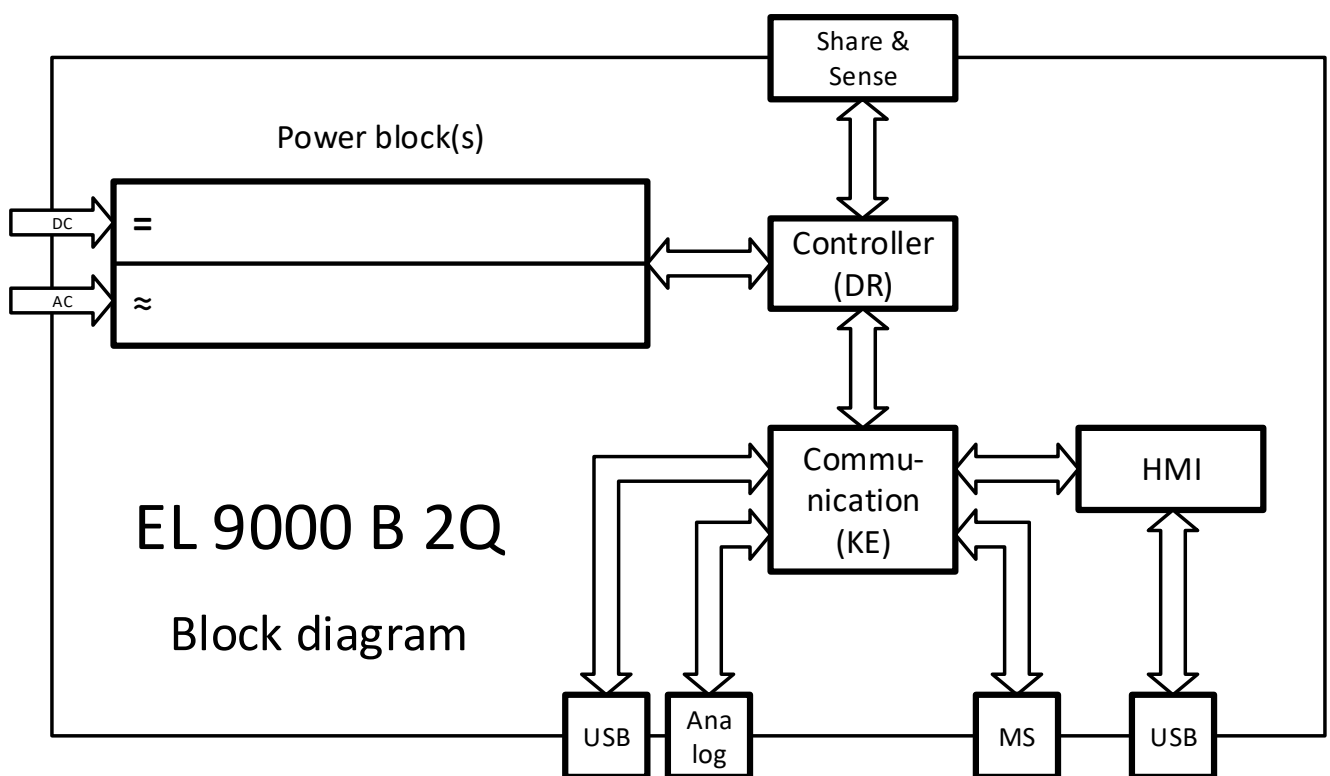

## 1.9.3 Scope of delivery

- 1 x Electronic load device
- 1 x Share Bus plug
- 1 x Remote sensing plug
- 2 x Fill strip (for the purpose see 2.3.3.1)
- 1 x 1.8 m USB cable
- 1 x Set of DC input cover(s)
- 1 x USB stick with documentation and software
- 1 x Mains cord (IEC / Schuko / 10 A or with UK 13 A plug, depending on shipping destination)

## 1.9.4 Accessories

For these devices the following accessories are available:

<b>IF-AB</b> Digital interface modules	Pluggable and retrofittable digital interface modules for RS232, CANopen, Ethernet, Profibus, ProfiNet, ModBus TCP or CAN are available.  Details about the interface modules and the programming of the device using those interfaces can be found in separate documentation. It's usually available on the USB stick which is included with the device or as PDF download on the EPS Stromversorgung website.
---	---

## 1.9.5 The control panel (HMI)

The HMI (Human Machine Interface) consists of six colored LEDs, a pushbutton and an USB-B port.

### 1.9.5.1 Status indicators (LED)

The six colored LEDs on the front indicate various statuses of the device:

LED	Color	Indicates what when lit?
<b>Power</b>	orange / green	Orange = device is in boot phase or internal error occurred Green = device is ready for operation
<b>Remote</b>	green	Remote control by master or any of the USB ports is active. In this situation, manual control with button On/Off is locked.
<b>Error</b>	red	At least one unacknowledged device alarm is active. The LED can signalize all alarms as listed in „3.6. Alarms and monitoring“.
<b>CC</b>	yellow	Constant current regulation (CC) is active. It means, if the LED is not lit it indicates either CV, CP or CR mode. Also see „3.2. Operating modes“.
<b>On</b>	green	DC input is switched on
<b>Off</b>	red	DC input is switched off

### 1.9.5.2 USB port

The front USB port is easier to access than the one on the rear side and intended for quick setup of DC input related values and settings. Doing so is necessary for normal two-quadrants operation, because it requires correct setup. In another situation, when master-slave operation is run and the EL 9000 B 2Q usually will be a slave unit, the configuration is overwritten by the master unit and the slave can only be monitored via this port.

When running any of the above listed situations following applies for the USB port:



- Reduced instruction set for master-slave configuration, input values (U, I, P, R) and protections (OVP, OCP, OPP). For details about the instruction set see „3.5. Remote control“.
- Taking over remote control in order to change the configuration is only possible while the unit is not under control from a master in master-slave operation, so it would either require to temporarily deactivate master-slave on the master or to switch the master off

### 1.9.5.3 Pushbutton “On / Off”



This button can be used to switch the DC input on or off during manual control, i.e. the device is not in remote control, by a master in master-slave or via any of the USB ports (LED “Remote” = off). Once pushed to switch the DC input on, the device would regulate the input to the last values it has stored. Since all the input related values are not displayed, operating that button has to be done with caution.

## 1.9.6 USB-Port Type B (Back side)

The USB-B port on the back side of the device is provided for communication with the device and for firmware updates. The included USB cable can be used to connect the device to a PC (USB 2.0 or 3.0). The driver is delivered on the included medium (USB stick) and installs a virtual COM port.

The device can be addressed via this port either using the international standard ModBus protocol or by SCPI language. The device recognizes the message protocol used automatically. Details for remote control can be found on the web site of EPS Stromversorgung or on the included medium.

If remote control is in operation the USB port has no priority over either the interface module (see below) or the analog interface and can, therefore, only be used alternatively to these. However, monitoring is always available.

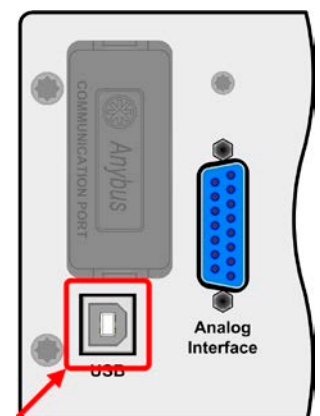

## 1.9.7 Interface module slot

This slot on the back side of the device is used to install one of various modules of the IF-AB interface series. The following options are available:

Ordering no.	Name	Description
35400100	IF-AB-CANO	CANopen, 1x Sub-D 9pole male
35400101	IF-AB-RS232	RS 232, 1x Sub-D 9pole male (null modem)
35400103	IF-AB-PBUS	Profibus DP-V1 Slave, 1x Sub-D 9pole female
35400104	IF-AB-ETH1P	Ethernet, 1x RJ45
35400105	IF-AB-PNET1P	ProfiNET IO, 1x RJ45
35400107	IF-AB-MBUS1P	ModBus TCP, 1x RJ45
35400108	IF-AB-ETH2P	Ethernet, 2x RJ45
35400109	IF-AB-MBUS2P	ModBus TCP, 2x RJ45
35400110	IF-AB-PNET2P	ProfiNET IO, 2x RJ45
35400111	IF-AB-CAN	CAN 2.0A & 2.0B, 1x Sub-D 9pole male
35400112	IF-AB-ECT	EtherCAT, 1x RJ45

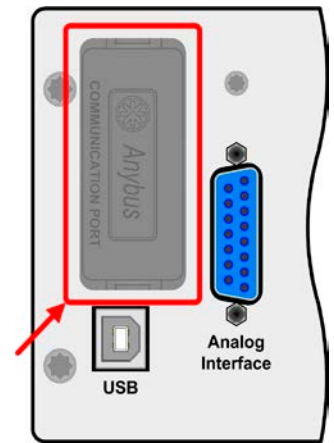

The modules are installed by the user and can be retrofitted without problem. A firmware update of the device may be necessary in order to recognize and support certain modules.

If remote control is in operation the interface module has no priority over either the USB port or the analog interface and can, therefore, only be used alternately to these. However, monitoring is always available.



**Switch off device before adding or removing modules!**

## 1.9.8 Analog interface

This 15 pole Sub-D socket on the back side of the device is provided for remote control of the device via analog or digital signals.

If remote control is in operation this analog interface can only be used alternately to the digital interface. However, monitoring is always available.

The input voltage range of the set values and the output voltage range of the monitor values, as well as reference voltage level can be switched between 0-5 V and 0-10 V, in each case for 0-100%. This is done via software EPS Power Control or any other software using a specific configuration command.

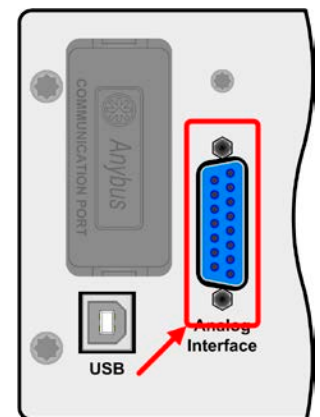

## 1.9.9 "Share" connector

The 2 pole socket ("Share") on the back side of the device is provided for connection to equally named sockets on compatible electronic loads when establishing parallel connection where symmetric current distribution is required, as well as compatible power supplies to build a two-quadrants operation setup. For details about this feature refer to „3.7.3. Parallel operation in master-slave (MS)“ and „3.7.1. Two quadrants operation (2QO)“. Following power supply and electronic load series are compatible:

- PSI 9000 2U - 24U
- ELR 9000
- EL 9000 B / EL 9000 B HP / EL 9000 B 2Q
- PSE 9000
- PS 9000 1U / 2U / 3U \*

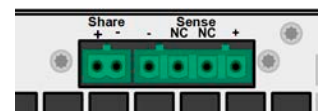

\* From hardware revision 2, see type label of those series (in case it does not show "Revision" on type label, it's revision 1)

### 1.9.10 “Sense” connector (remote sensing)

In order to compensate for voltage drops along the DC cables from the source, the Sense input can be connected to the source. The maximum possible compensation is given in the technical data. For more refer to „2.3.7. Connection of remote sensing“.



In order to ensure safety and to comply to international directives the insulation of high voltage models, i. e. those with a rated voltage of 500 V or higher, is ensured by using only the two outer pins of the 4-pole terminal. The inner two pins, marked with NC, must remain unconnected.

### 1.9.11 Master-Slave bus

A further port is provided on the back side of the device, comprising two RJ45 sockets, which enables multiple devices of the same model to be connected via a digital bus (RS485) to create a master-slave system. Connection is made using standard CAT5 cables. It can theoretically have a length of up to 1200 m, but it's recommended to keep the connections as short as possible. For more refer to „3.7.3. Parallel operation in master-slave (MS)“.

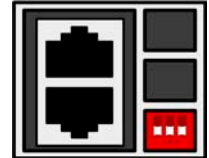

## 2. Installation & commissioning

### 2.1 Transport and storage

#### 2.1.1 Transport



- The handles on the front side of the device are **not** for carrying!
- Because of its weight, transport by hand should be avoided where possible. If unavoidable then only the housing should be held and not on the exterior parts (handles, DC input terminal, rotary knobs).
- Do not transport while the device is powered or connected to a voltage source!
- When relocating the equipment use of the original packing is recommended
- The device should always be carried and mounted horizontally
- Use suitable safety clothing, especially safety shoes, when carrying the equipment, as due to its weight a fall can have serious consequences!

#### 2.1.2 Packaging

It's recommended to keep the complete transport packaging for the lifetime of the device for relocation or return to EPS Stromversorgung for repair. Otherwise the packaging should be disposed of in an environmentally friendly way.

#### 2.1.3 Storage

In case of long term storage of the equipment it's recommended to use the original packaging or similar. Storage must be in dry rooms, if possible in sealed packaging, to avoid corrosion, especially internal, through humidity.

## 2.2 Unpacking and visual check

After every transport, with or without packaging, or before commissioning, the equipment should be visually inspected for damage and completeness using the delivery note and/or parts list (see section „1.9.3. *Scope of delivery*“). An obviously damaged device (e. g. loose parts inside, damage outside) must under no circumstances be put in operation.

## 2.3 Installation

### 2.3.1 Safety procedures before installation and use



- Make sure the proposed location of the equipment (table, cabinet, shelf, 19" rack) must be able to support the weight without restriction.
- When using a 19" rack, rails suitable for the width of the housing and the weight of the device are to be used. (see „1.8.3. *Specific technical data*“)
- Before connecting to the mains ensure that the connection is as shown on the product label. Overvoltage on the AC supply can cause equipment damage.
- Before connecting a voltage source to the DC input make sure, that the source can't generate a voltage higher than specified for a particular model or install measures which can prevent damaging the device by overvoltage input

## 2.3.2 Preparation

Connection to mains of electronic loads of EL 9000 B 2Q only requires a standard wall socket. The mains cord is included in the scope of delivery. The devices only consume little power, so there are no further installation or safety measures required. The loads can also be operated together with different devices on the same distribution box.



High inrush current! Circuit breakers with wrong characteristics could trigger unexpectedly. We recommend type C breakers for external fusing or other with a high inrush current capability.

## 2.3.3 Installing the device



- Select the location for the device so that the connection to the source is as short as possible.
- Leave sufficient space behind the equipment, minimum 30 cm, for ventilation of warm or hot air that will be exhausted.

A device in a 19" housing will usually be mounted on suitable rails and installed in 19" racks or cabinets. The depth of the device and its weight must be taken into account. The handles on the front are for sliding in and out of the cabinet. Slots on the front plate are provided for fixing the device (fixing screws not included with the device).

Acceptable and unacceptable installation positions:

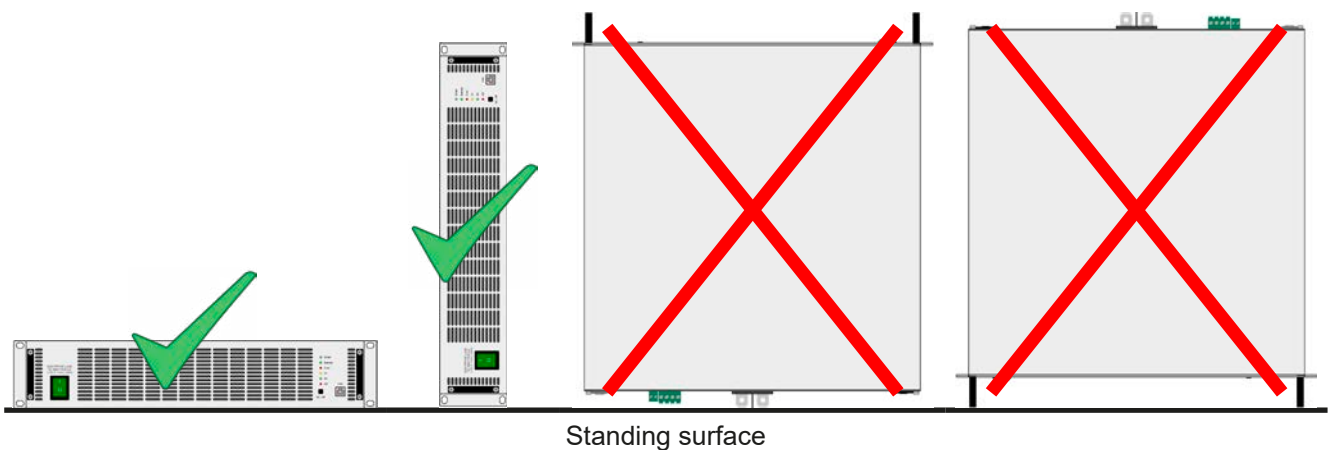

### 2.3.3.1 Convert to desktop version

The device is primarily designed for installation in 19" racks and cabinets, but it can also be used as desktop device. For that, the 19" fixing brackets on the left and right edge of the front plate could be disturbing. In order to remove them and convert the device into a "desktop version", do following:

1. Unscrew the black handles on the front (hexagon screws) and put them aside.
2. Remove the fixing brackets on the sides by simply pulling them out.
3. Insert the included fill strips () so the drilling holes match the ones on the front plate
4. Screw the black handles again.

### 2.3.4 Connection to DC sources



In the case of a device with a high nominal current and hence a thick and heavy DC connection cable it's necessary to take account of the weight of the cable and the strain imposed on the DC connection. Especially when mounted in a 19" cabinet or similar, where the cable hangs on the DC input, a strain reliever has to be used.

The DC input is on the back side of the device and is **not** protected by a fuse. The cross section of the connection cable is determined by the current consumption, cable length and ambient temperature.

For cables up to **5 m** and average ambient temperature up to 50 °C, we recommend:

up to <b>20 A</b> :	4 mm <sup>2</sup>	up to <b>40 A</b> :	6 mm <sup>2</sup>
up to <b>70 A</b> :	16 mm <sup>2</sup>	up to <b>85 A</b> :	25 mm <sup>2</sup>
up to <b>170 A</b> :	70 mm <sup>2</sup>		

**per connection pole** (multi-conductor, insulated, openly suspended). Single cables of, for example, 70 mm<sup>2</sup> may be replaced by 2x 25 mm<sup>2</sup> etc. If the cables are long then the cross section must be increased to avoid voltage loss and overheating.

#### 2.3.4.1 DC terminal

The table below shows an overview of the various DC terminals. It's recommended that connection of load cables always utilizes flexible cables with ring lugs.



M6 bolt on a nickel plated copper bar

Recommendation: Ring lugs with a 6 mm hole

#### 2.3.4.2 Cable lead and plastic cover

A plastic cover for contact protection is included for the DC terminal. It should always be installed.



*The connection angle and the required bending radius for the DC cable must be taken into account when planning the depth of the complete device, especially when installing in a 19" cabinet or similar. In case, the plastic DC cover is going to be used, only horizontal lead of the cables is possible.*



## 2.3.5 Grounding of the DC input

The device can always be grounded on the DC minus pole, i.e. can be directly connected to PE. The DC plus pole, however, if it's to be grounded, may only be so for input voltages up to 400 V, because the potential of the minus pole is shifted into negative direction by the value of the input voltage. Also see technical specification sheets in 1.8.3, item "Insulation".

For this reason, for all models which can support an input voltage higher than 400 V grounding of the DC plus pole is not allowed.



- Do not ground the DC plus pole on any model with >400 V nominal voltage
- If grounding one of the input poles ensure that no output pole of the source (e. g. power supply) is grounded. This could lead to a short-circuit!

## 2.3.6 Connecting the "Share" bus

The "Share" bus connector on the rear side is intended to balance the power of multiple units in parallel operation, especially when using the integrated function generator of a master unit (EL 9000 B HP). Alternatively, it can be connected to a compatible power supply, like from series PSI 9000 2U, in order to run a two-quadrants operation. For further information about this mode of operation can be found in section „3.7.1. Two quadrants operation (2QO)“.

## 2.3.7 Connection of remote sensing



- Both pins "NC" on the "Sense" terminal must not be connected!
- This series features models with up to 750 V DC rated voltage, so it's required to only use remote sensing leads with proper electric strength



- *Remote sensing is only effective during constant voltage operation (CV) and for other regulation modes the sense input should be disconnected, if possible, because connecting it generally increases the oscillation tendency.*
- *The cross section of the sensing cables is noncritical. Recommendation for cables up to 5 m: use at least 0.5 mm<sup>2</sup>*
- *Sensing cables should be twisted and laid close to the DC cables to damp oscillation. If necessary, an additional capacitor should be installed at the source to eliminate oscillation*
- *Sensing cables must be connected + to + and - to - at the source, otherwise the sense input of the electronic load can be damaged. For an example see Figure 7 below.*
- *In master-slave operation, the remote sensing should be connected to the master unit only*

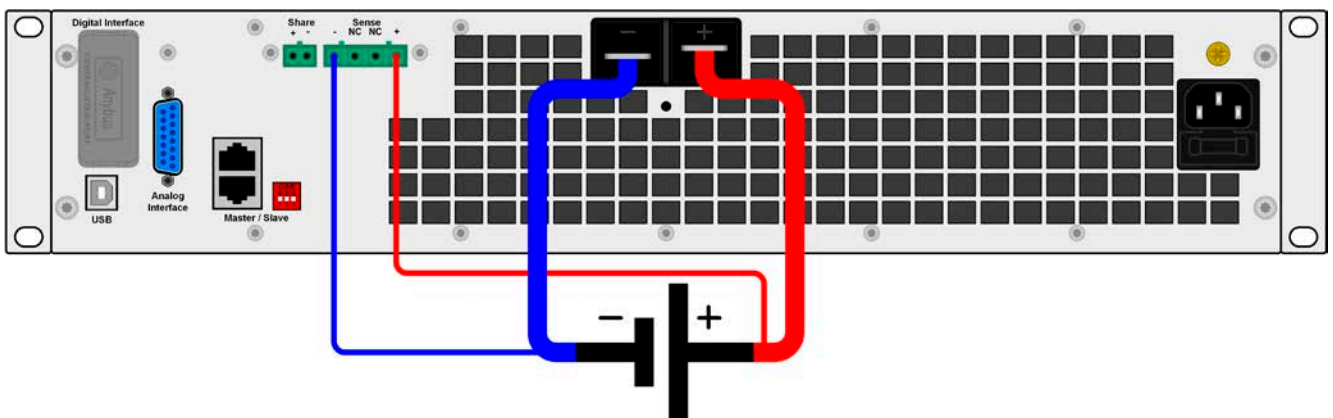

Figure 7 - Principle of wiring the remote sensing

### 2.3.8 Connecting the USB ports

In order to remotely control the device via any of these port, connect the device with a PC using the included USB cable and switch the device on.

#### 2.3.8.1 Driver installation (Windows)

On the initial connection with a PC the operating system will identify the device as new hardware and will try to install a driver. The required driver is for a Communication Device Class (CDC) device and is usually integrated in current operating systems such as Windows 7 or 10. But it's strongly recommended to use the included driver installer (on USB stick) to gain maximum compatibility of the device to our softwares.

#### 2.3.8.2 Driver installation (Linux, MacOS)

We can't provide drivers or installation instructions for these operating systems. Whether a suitable driver is available can be found out by searching the Internet.

#### 2.3.8.3 Alternative drivers

In case the CDC driver described above are not available on your system, or for some reason do not function correctly, commercial suppliers can help. Search the Internet for suppliers using the keywords "cdc driver windows" or "cdc driver linux" or "cdc driver macos".

### 2.3.9 Installation of an interface module

The various interface modules can be retrofitted by the user and are exchangeable with each other. The settings for the currently installed module vary and need to be checked and, if necessary, corrected on initial installation and after module exchange.



- Common ESD protection procedures apply when inserting or exchanging a module!
- The device must be switched off before insertion or removal of a module!
- Never insert any other hardware other than these interface modules into the slot!
- If no module is in use it's recommended that the slot cover is mounted in order to avoid internal dirtying of the device and changes in the air flow

Installation steps:

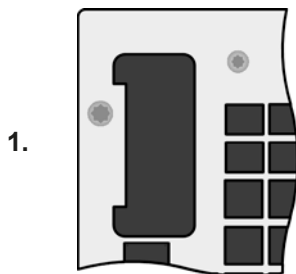

Remove the slot cover. If needed use a screw driver.

Check that the fixing screws of an already installed module are fully retracted. If not, unscrew them (Torx 8) and remove module.

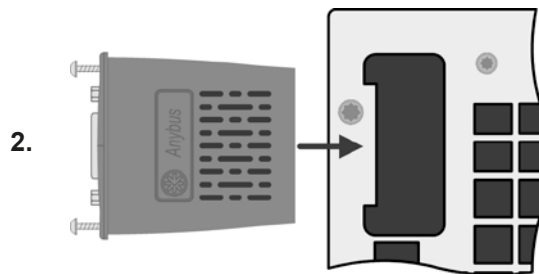

Insert the interface module into the slot. The shape ensures correct alignment.

When inserting take care that it's held as close as possible to a 90 ° angle to the rear wall of the device. Use the green PCB, which you can recognize on the open slots, as guide. At the end is a socket for the module.

On the bottom side of the module are two plastic nibs which must click into the green PCB so that the module is properly aligned on the rear wall of the device.

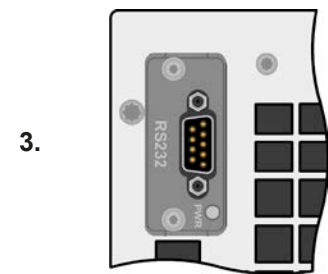

Slide the module into place as far as it will go.

The screws (Torx 8) are provided for fixing the module and should be fully screwed in. After installation, the module is ready for use and can be connected.

Removal follows the reverse procedure. The screws can be used to assist in pulling out the module.

## 2.3.10 Connecting the analog interface

The 15 pole connector (Type: Sub-D, D-Sub) on the rear side is an analog interface. To connect this to a controlling hardware (PC, electronic circuit), a standard plug is necessary (not included in the scope of delivery). It's generally advisable to switch the device completely off before connecting or disconnecting this connector, but at least the DC input.

## 2.3.11 Initial commission

For the first start-up after purchasing and installing the device, the following procedures have to be executed:

- Confirm that the connection cables to be used are of a satisfactory cross section!
- Check if the factory settings of set values, safety and monitoring functions and communication are suitable for your intended application of the device and adjust them if required, as described in the manual!
- In case of remote control via PC, read the additional documentation for interfaces and software!
- In case of remote control via the analog interface, read the section in this manual concerning analog interfaces!

## 2.3.12 Commission after a firmware update or a long period of non-use

In case of a firmware update, return of the equipment following repair or a location or configuration change, similar measures should be taken to those of initial start up. Refer to „2.3.11. *Initial commission*“.

Only after successful checking of the device as listed may it be operated as usual.

### 3. Operation and application

#### 3.1 Personal safety



- In order to guarantee safety when using the device, it's essential that only persons operate the device who are fully acquainted and trained in the required safety measures to be taken when working with dangerous electrical voltages
- For models which accept dangerous voltages, the included DC terminal cover, or an equivalent, must always be used
- Whenever the DC input is being re-configured, you must switch off or even better, disconnect the source!

#### 3.2 Operating modes

An electronic load is internally controlled by different control or regulation circuits, which shall bring voltage, current and power to the adjusted values and hold them constant, if possible. These circuits follow typical laws of control systems engineering, resulting in different operating modes. Every operating mode has its own characteristics which is explained below in short form.

##### 3.2.1 Voltage regulation / Constant voltage

Constant voltage operation (CV) or voltage regulation is a subordinate operating mode of electronic loads. In normal operation, a voltage source is connected which represents a certain input voltage for the load. If the voltage set value is higher than the actual input voltage, the load would draw no current from the source. If the voltage set value is lower than the input voltage the load would always attempt to sink enough current from the source to achieve the desired voltage level. If the resulting current reaches the adjusted current limit or the adjusted power limit according to  $P = U_{IN} \cdot I_{IN}$ , the load will automatically switch to constant current or constant power operation, whatever comes first. Then the adjusted input voltage can no longer be achieved.

While the DC input is switched on and constant voltage mode is active, then the condition "CV mode active" will be passed as a signal to the analog interface and stored as internal status which can be read via digital interface.

##### 3.2.1.1 Speed of the voltage controller

The internal voltage controller can be switched between "Slow" and "Fast" via remote configuration. Factory default is "Slow". Which setting to select depends on the actual situation in which the device is going to be operated, but it primarily depends on the type of voltage source. An active, regulated source such as a switching mode power supply has its own voltage control circuit which works concurrently to the load's circuit. This can cause oscillation. If this occurs it's recommended to set the controller speed to "Slow".

In other situations, e. g. operating the function generator and applying various functions to the load's input voltage and setting of small time increments, it might be necessary to set the voltage controller to "Fast" in order to achieve the expected results.

##### 3.2.1.2 Minimum voltage for maximum current

Due to technical reasons, all models in this series have a minimum internal resistance that makes the unit to be supplied with a minimum input voltage ( $U_{MIN}$ ) in order to be able to draw the full current ( $I_{MAX}$ ). This minimum input voltage varies from model to model and is listed in the technical specifications. If less voltage than  $U_{MIN}$  is supplied, the load proportionally draws less current, which can be calculated easily.

See principle view to the right.

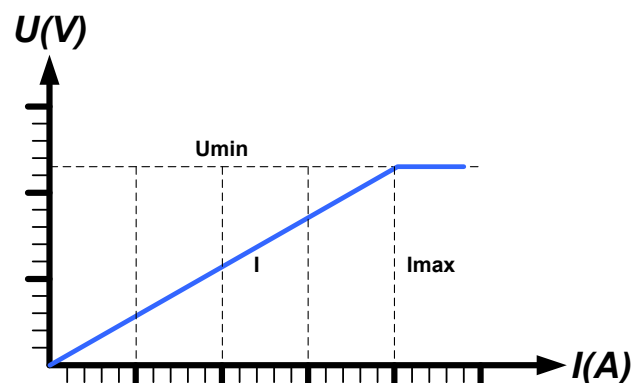

### 3.2.2 Current regulation / constant current / current limitation

Current regulation is also known as current limitation or constant current mode (CC) and is fundamental to the normal operation of an electronic load. The DC input current is held at a predetermined level by varying the internal resistance according to Ohm's law  $R = U / I$  such that, based on the input voltage, a constant current flows. Once the current has reached the adjusted value, the device automatically switches to constant current mode. However, if the power consumption reaches the adjusted power level, the device will automatically switch to power limitation and adjust the input current according to  $I_{MAX} = P_{SET} / U_{IN}$ , even if the maximum current set value is higher. The current set value, as determined by the user, is always and only an upper limit.

While the DC input is switched on and constant current mode is active, the condition "CC mode active" will be shown on the HMI via LED **CC**, as well it will be passed as a signal to the analog interface and stored as internal status which can be read via digital interface.

### 3.2.3 Resistance regulation / constant resistance

Inside electronic loads, whose operating principle is based on a variable internal resistance, constant resistance mode (CR) is almost a natural characteristic. The load attempts to set the internal resistance to the user defined value by determining the input current depending on the input voltage according to Ohm's law  $I_{IN} = U_{IN} / R_{SET}$ . The internal resistance is naturally limited between almost zero and a certain maximum where the resolution of the current measuring becomes too inaccurate. As the internal resistance can't have a value of zero, the lower limit is defined to an achievable minimum. This ensures that the electronic load, at very low input voltages, can consume a high input current from the source, up to the rated current.

While the DC input is switched on and constant resistance mode is active, the condition "CR mode active" won't be indicated directly, but can be read as internal status via any digital interface.

### 3.2.4 Power regulation / constant power / power limitation

Power regulation, also known as power limitation or constant power (CP), keeps the DC input power of the device constant as soon as the current flowing into the load in connection with the input voltage according to  $P = U * I$  reaches the adjusted power limit. The load would then regulate the input current according to  $I_{IN} = P_{SET} / U_{IN}$ , as long as the power source is able to provide this power.

Power limitation operates according to the auto-range principle such that at lower input voltages higher current can flow and vice versa, in order to maintain constant power within the range  $P_N$  (see diagram to the right).

While the DC input is switched on and constant power operation is active, the condition "CP mode active" won't be indicated directly, but can be read as internal status via any digital interface.

Constant power operation impacts the internal set current value. This means that the maximum set current may not be reachable if the set power value according to  $I = P / U$  sets a lower current. The user defined and displayed set current value is always the upper limit only.

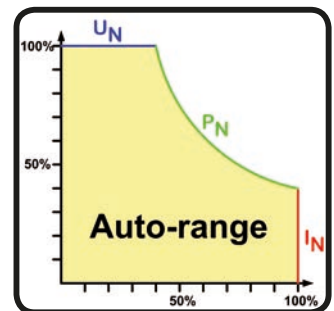

#### 3.2.4.1 Temperature dependent derating

This series consists of conventional electronic loads which convert the consumed electrical energy into heat and dissipate it into the environment. In order to avoid overheating, the device will automatically reduce, i.e. derate the true input power when heating up. This derating is directly depending on the ambient temperature.

All models can take their rated input power up to an ambient temperature of 30°C (86°F). Above this limit, the max. input power is linearly derated.

In situations where the device is supplied with less power than rated, the derating won't impact the operation. However, the internal power reduction could still be active. For example, when running a model with 2400 W rated power at 1600 W actual power and 2400 W as power set value, plus an increased ambient temperature above 30°C (86°F), and your source would do a voltage step or the load would do a current step, the adjusted power limit of 2400 W could still not be achieved.

Principle view of the derating characteristics:

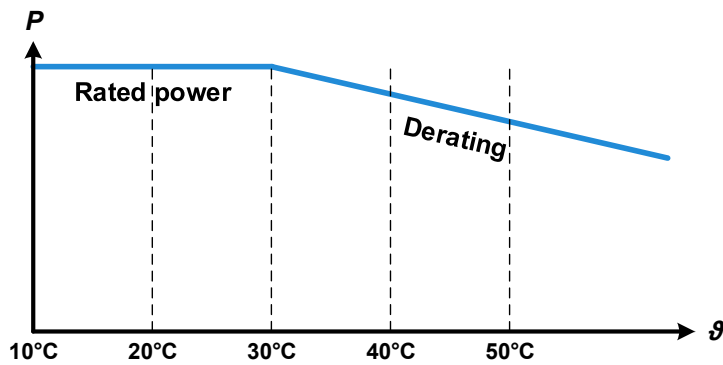

Starting at around 30°C (86°F) ambient temperature, the derating will continuously step down the available input power.

The temperature range of the device is rated up to 50°C (122°F). Above that point, the system could shut down because of overtemperature (OT). However, due to the continuous derating that will happen, if at all, only above 80°C (176°F).

### 3.2.5 Dynamic characteristics and stability criteria

The electronic load is characterized by short rise and fall times of the current, which are achieved by a high bandwidth of the internal regulation circuit.

In case of testing sources with own regulation circuits at the load, like for example power supplies, a regulation instability may occur. This instability is caused if the complete system (feeding source and electronic load) has too little phase and gain margin at certain frequencies. 180 ° phase shift at > 0dB amplification fulfills the condition for an oscillation and results in instability. The same can occur when using sources without own regulation circuit (eg. batteries), if the connection cables are highly inductive or inductive-capacitive.

The instability is not caused by a malfunction of the load, but by the behavior of the complete system. An improvement of the phase and gain margin can solve this. In practice, a capacity is directly connected to the DC input of the load. The value to achieve the expected result is not defined and has to be found out. We recommend:

80 V models: 1000 µF...4700 µF

200 V models: 100 µF...470 µF

360 V models: 68 µF...220 µF

500 V models: 47 µF...150 µF

750 V models: 22 µF...100 µF



### 3.3 Alarm conditions



*This section only gives an overview about device alarms. What to do in case your device indicates an alarm condition is described in section „3.6 Alarms and monitoring“ on page 39.*

As a basic principle, all alarm conditions are signaled optically (by LED “Error” on the front) and via the digital interface ports. For later acquisition, an alarm counter can be read via digital interface.

Some alarms require acknowledgment before the DC input can be switched on again, in those cases where the alarm caused to switch it off. Acknowledgment in normal master-slave operation is done on the master unit. In other situations, like during manual operation it can be done with the pushbutton “On / Off” on the front or else by sending a specific command via digital interface.

#### 3.3.1 Power Fail

Power Fail (PF) indicates an alarm condition which may have various causes:

- AC input voltage too low (mains undervoltage, mains failure)

As soon as a power fail occurs, the device will stop to sink power and switch off the DC input. In case the power fail was an undervoltage and is gone later on, the alarm will vanish and doesn't require to be acknowledged.



*Switching off the device by the mains switch can't be distinguished from a mains blackout and thus the device will signalize an alarm via LED “Error” every time. This can be ignored.*



*The condition of the DC input after a PF alarm during operation when the device remains powered, i.e. like after a temporary blackout, can be set up via a specific configuration command.*

#### 3.3.2 Overtemperature

An overtemperature alarm (OT) can occur due to an excess temperature inside the device and causes it to stop sinking power temporarily. After cooling down, the device will automatically continue to supply power, while the condition of the DC input remains and the alarm doesn't require to be acknowledged.

#### 3.3.3 Overvoltage

An overvoltage alarm (OVP) will switch off the DC input and can occur if:

- the connected voltage source provides a higher voltage to the DC input than set in the overvoltage alarm threshold (OVP, 0...103%  $U_{NOM}$ )

This function serves to warn the user of the electronic load acoustically or optically that the connected voltage source has generated an excessive voltage and thereby could damage or even destroy the input circuit and other parts of the device.



The device is not fitted with protection from external overvoltage.

#### 3.3.4 Overcurrent

An overcurrent alarm (OCP) will switch off the DC input and can occur if:

- The input current in the DC input exceeds the adjusted OCP limit.

This function serves to protect the voltage and current source so that this is not overloaded and possibly damaged, rather than offering protection to the electronic load.

#### 3.3.5 Overpower

An overpower alarm (OPP) will switch off the DC input and can occur if:

- the product of the input voltage and input current in the DC input exceeds the adjusted OPP limit.

This function serves to protect the voltage and current source so that this is not overloaded and possibly damaged, rather than offering protection to the electronic load.

## 3.4 Manual operation

### 3.4.1 Powering the device

The device should, as far as possible, always be switched on using the toggle switch on the front of the device. Alternatively this can take place using an external cutout (contactor, circuit breaker) of suitable current capacity.

After switching on, the device indicates the boot phase with LED "Power" on the front being **orange**. Once it has finished starting and is ready for operation, LED "Power" changes to **green**.

There is a configurable option which determines the condition of the DC input after power-up. Factory setting here is "OFF". Changing it to "Restore" will cause the device to restore the last DC input condition, either on or off.

In master-slave operation and when the device is being slave, all values and conditions are stored and restored by the master, overwriting the slaves' settings.



*During the start phase of the device the analog interface can signal undefined statuses on the output pins such as ALARMS 1. Those signals must be ignored until the device has finished booting and is ready to work.*

### 3.4.2 Switching the device off

On switch-off, the last input condition and the most recent set values and input status, as well as activated master-slave operation are saved. Furthermore, a alarm (power failure) will be indicated by LED "Error", but has to be ignored here.

The DC input is immediately switched off. The device will be completely powered off shortly after that.

### 3.4.3 Switching the DC input on or off

As long as the device is not in remote control by a master unit or by a software via USB interface, the DC input can be manually switched on or off with the pushbutton "On / Off". This is for situations where the device needs to be operated stand-alone or as substitute of a failed or missing master. The same situation also allows for access to all DC input related parameters via the front USB port. The button can also be used to acknowledge device alarms signaled by LED "Error".

For the configuration of parameters see section 3.5 and the included programming guide. The software EPS Power Control can also be used to configure a few of the parameters.



## 3.5 Remote control

### 3.5.1 General

Remote control is possible via the built-in analog or any of the digital interfaces. Digital interfaces are the two USB ports, the optional interface modules and also the closed master-slave bus, via which the device could be controlled by a master unit in master-slave operation.

Important here is that only the analog or one of the digital interfaces can be in control. It means that if, for example, an attempt were to be made to switch to remote control via the digital interface whilst analog remote control is active, the device would report an error via the digital interface. In the opposite direction a switch-over via pin **Remote** would be ignored. In all cases, however, status monitoring and reading of values are always possible.

### 3.5.2 Remote control via the rear USB port or interface module

#### 3.5.2.1 Selecting an interface

All models of series EL 9000 B 2Q support, in addition to the built-in rear USB port, the following optionally available interface modules:

Short ID	Type	Ports	Description*
IF-AB-CANO	CANopen	1	CANopen slave with generic EDS
IF-AB-RS232	RS232	1	Standard RS232, serial
IF-AB-PBUS	Profibus	1	Profibus DP-V1 slave
IF-AB-ETH1P	Ethernet	1	Ethernet TCP
IF-AB-PNET1P	ProfiNet	1	Profinet DP-V1 slave
IF-AB-MBUS	ModBus TCP	1	ModBus TCP/RTU protocol via Ethernet
IF-AB-ETH2P	Ethernet	2	Ethernet TCP, with switch
IF-AB-MBUS2P	ModBus TCP	2	ModBus TCP/RTU protocol via Ethernet
IF-AB-PNET2P	ProfiNet	2	Profinet DP-V1 slave, with switch
IF-AB-CAN	CAN	1	Modified ModBus RTU via CAN
IF-AB-ECT	EtherCAT	2	Basic EtherCAT slave with CANopen over Ethernet (CoE)

\* For technical details of the various modules see the extra documentation "Programming Guide Modbus & SCPI"

#### 3.5.2.2 General information about the interface modules

For installation see section „2.3.9. *Installation of an interface module*“.

The modules require little or no settings for operation and can be directly used with their default configuration. All specific settings will be permanently stored such that, after changeover between the various models, no re-configuration will be necessary. Changing settings is done using remote control and specific configuration commands. Refer to the programming guide on the included USB stick. There are several ways to transfer these commands, such as LabView or SCPI via a terminal software.

#### 3.5.2.3 Programming

Programming details for the interfaces, the communication protocols etc. are to be found in the documentation "Programming Guide ModBus & SCPI" which is supplied on the included USB stick or which is available as download from the EPS Stromversorgung website.

### 3.5.3 Remote control via the front USB

The main purpose of the front USB port is quick access to the most important DC input related parameters, such as set values and protections. Reading values and status is always possible, setting them only while the device is not in control by a master device while running in master-slave operation.

Outside of master-slave, the device could be controlled remotely with software EPS **Power Control**, but also from custom applications. In order to do so, a programming documentation is delivered with the device on USB stick.

The number of available commands is restricted on this USB port, but it supports both, SCPI and ModBus RTU communication protocols. As part of the programming documentation, there is an extra ModBus **register list** (Modbus\_Register\_EL9000B\_2Q\_Front\_HMIx.xx+\_EN.pdf) for the front USB port.

In the **programming guide** "Programming SCPI & ModBus" is a separate section SCPI, but because this addresses all SCPI commands available here is an overview what commands are available with the front port. Details about all the commands can be found, however, in the programming guide.

*IDN?	SYSTem:ALARm:ACTion:PFAil
*CLS	SYSTem:ALARm:ACTion:PFAil?
*RST	SYSTem:ALARm:COUNT:OCURrent?
*ESE	SYSTem:ALARm:COUNT:OPOWER?
*ESE?	SYSTem:ALARm:COUNT:OTEMperature?
*ESR	SYSTem:ALARm:COUNT:OVOLTage?
*STB?	SYSTem:ALARm:COUNT:PFAil?
[SOURce:]CURRent	SYSTem:COMMunicate:TIMEout?
[SOURce:]CURRent?	SYSTem:CONFig:MODE
[SOURce:]CURRent:LIMit:HIGH?	SYSTem:CONFig:MODE?
[SOURce:]CURRent:LIMit:LOW?	SYSTem:CONFig:OCD
[SOURce:]CURRent:PROTection[:LEVel]	SYSTem:CONFig:OCD?
[SOURce:]CURRent:PROTection[:LEVel]?	SYSTem:CONFig:OCD:ACTion
[SOURce:]IRRAdiation	SYSTem:CONFig:OCD:ACTion?
[SOURce:]IRRAdiation?	SYSTem:CONFig:OPD
[SOURce:]POWER	SYSTem:CONFig:OPD?
[SOURce:]POWER?	SYSTem:CONFig:OPD:ACTion
[SOURce:]POWER:LIMit:HIGH?	SYSTem:CONFig:OPD:ACTion?
[SOURce:]POWER:PROTection[:LEVel]	SYSTem:CONFig:INPut:REStore
[SOURce:]POWER:PROTection[:LEVel]?	SYSTem:CONFig:INPut:REStore?
[SOURce:]RESistance	SYSTem:CONFig:OVD
[SOURce:]RESistance?	SYSTem:CONFig:OVD?
[SOURce:]RESistance:LIMit:HIGH?	SYSTem:CONFig:OVD:ACTion
[SOURce:]VOLTage	SYSTem:CONFig:OVD:ACTion?
[SOURce:]VOLTage?	SYSTem:CONFig:UCD
[SOURce:]VOLTage:LIMit:HIGH?	SYSTem:CONFig:UCD?
[SOURce:]VOLTage:LIMit:LOW?	SYSTem:CONFig:UCD:ACTion
[SOURce:]VOLTage:PROTection[:LEVel]	SYSTem:CONFig:UCD:ACTion?
[SOURce:]VOLTage:PROTection[:LEVel]?	SYSTem:CONFig:USER:TEXT
MEASure:[SCALar:]CURRent[:DC]?	SYSTem:CONFig:USER:TEXT?
MEASure:[SCALar:]POWER[:DC]?	SYSTem:CONFig:UVD
MEASure:[SCALar:]VOLTage[:DC]?	SYSTem:CONFig:UVD?
INPut[:STATe]	SYSTem:CONFig:UVD:ACTion
INPut[:STATe]?	SYSTem:CONFig:UVD:ACTion?
STATus:OPERation?	SYSTem:DEVice:CLAss?
STATus:QUEStionable?	SYSTem:ERRor:ALL?

SYSTem:ERRor:NEXt?	SYSTem:NOMinal:CURRent?
SYSTem:ERRor?	SYSTem:NOMinal:POWer?
SYSTem:LOCK	SYSTem:NOMinal:RESistance:MAXimum?
SYSTem:LOCK?	SYSTem:NOMinal:RESistance:MINimum?
SYSTem:LOCK:OWNer?	SYSTem:NOMinal:VOLTage?

## 3.5.4 Remote control via the analog interface (AI)

### 3.5.4.1 General

The built-in, galvanically isolated, 15-pole analog interface (short: AI) is on the back side of the device offers the following possibilities:

- Remote control of current, voltage, power and resistance
- Remote status monitoring (CV, DC input)
- Remote alarm monitoring (OT, OVP, PF, OPP, OCP)
- Remote monitoring of actual values
- Remote on/off switching of the DC input

Setting the **three** set values for voltage, current and power via the analog interface must always be done **concurrently**. It means, that for example the voltage can't be given via the AI while current and power are set via digital interface or vice versa. Resistance mode is additionally possible and requires to feed a fourth set value.

The OVP set value and other supervision (events) and alarm thresholds can't be set via the AI and therefore must be adapted to the given situation before the AI will be in control. Analog set values can be supplied by an external voltage or generated from the reference voltage on pin 3.

The AI can be operated in the common voltage ranges 0...5 V and 0...10 V in each case 0...100% of the nominal value. The selection of the voltage range can be done via software configuration, such as with EPS Power Control.

The reference voltage sent out from Pin 3 (VREF) will be adapted accordingly:

**0-5 V:** Reference voltage = 5 V, 0...5 V set value signal for VSEL, CSEL, PSEL, RSEL correspond to 0...100% nominal value respectively  $R_{MIN}...R_{MAX}$  and 0...100% actual values correspond to 0...5 V at the actual value outputs CMON and VMON.

**0-10 V:** Reference voltage = 10 V, 0...10 V set value signal for VSEL, CSEL, PSEL, RSEL correspond to 0...100% nominal value respectively  $R_{MIN}...R_{MAX}$  and 0...100% actual values correspond to 0...10 V at the actual value outputs CMON and VMON.

Regular and excess signals (e. g. >5 V in selected 5 V range or >10 V in the 10 V range) are always clipped to the adjustment limits which are by default set to 102% of the rated for this series, but can be configured differently by any user.

### Before you begin, please read these important notes about the use of the interface:

- Analog remote control of the device must be activated by switching pin REMOTE (5) first. Only exception is pin REM-SB, which can be used independently
- Before the hardware is connected that will control the analog interface, it shall be checked that it can't provide voltage to the pins higher than specified
- Set value inputs, such as VSEL, CSEL, PSEL and RSEL (if R mode is activated), must not be left unconnected (i.e. floating) during analog remote control. In case any of the set values is not used for adjustment, it can be tied to a defined level or connected to pin VREF (solder bridge or different), so it gives 100%

### 3.5.4.2 Acknowledging device alarms

Device alarms (see 3.6.2) are always indicated via LED "Error" on the front and most of them are also reported as signal on the analog interface socket (see table below).

In case of a device alarm occurring during remote control via analog interface, the DC input will be switched off the same way as in other control modes.

Some device alarms have to be acknowledged, either by the user of the device or by the controlling unit. Also see „3.6.2. Device alarm and event handling“. Acknowledgment is done with pin REM-SB switching the DC input off and on again, means a HIGH-LOW-HIGH edge (at least 50 ms for LOW), when using the default level setting for this pin.

## 3.5.4.3 Resolution of analog set and actual values

The analog interface is internally sampled and processed by a digital microcontroller. This causes a limited resolution of analog steps. The resolution is the same for set values (VSEL etc.) and actual values (VMON/CMON) and is 26214 when working with the 10 V range. In the 5 V range this resolution halves. Due to tolerances, the truly achievable resolution can be slightly lower.

## 3.5.4.4 Analog interface specification

Pin	Name	Type*	Description	Default levels	Electrical specification
1	VSEL	AI	Set voltage value	0...10 V or. 0...5 V correspond to 0..100% of $U_{Nom}$	Accuracy 0-5 V range: < 0.4% ***** Accuracy 0-10 V range: < 0.2% ***** Input impedance $R_i > 40\text{ k} \dots 100\text{ k}$
2	CSEL	AI	Set current value	0...10 V or. 0...5 V correspond to 0..100% of $I_{Nom}$	
3	VREF	AO	Reference voltage	10 V or 5 V	Tolerance < 0.2% at $I_{max} = +5\text{ mA}$ Short-circuit-proof against AGND
4	DGND	POT	Digital ground		For control and status signals
5	REMOTE	DI	Remote control	Remote = LOW, $U_{Low} < 1\text{ V}$ Internal = HIGH, $U_{High} > 4\text{ V}$ Internal, when unconnected	Voltage range = 0...30 V $I_{Max} = -1\text{ mA}$ bei 5 V $U_{LOW\text{ to HIGH typ.}} = 3\text{ V}$ Rec'd sender: Open collector against DGND
6	ALARMS 1	DO	Overheating alarm / Power fail	Alarm = HIGH, $U_{High} > 4\text{ V}$ No alarm = LOW, $U_{Low} < 1\text{ V}$	Quasi open collector with pull-up against $V_{cc}^{**}$ With 5 V on the pin max. flow +1 mA $I_{Max} = -10\text{ mA}$ at $U_{CE} = 0,3\text{ V}$ $U_{Max} = 30\text{ V}$ Short-circuit-proof against DGND
7	RSEL	AI	Set internal resistance value	0...10 V or. 0...5 V correspond to 0..100% of $R_{Max}$	Accuracy 0-5 V range: < 0.4% ***** Accuracy 0-10 V range: < 0.2% ***** Input impedance $R_i > 40\text{ k} \dots 100\text{ k}$
8	PSEL	AI	Set power value	0...10 V or. 0...5 V correspond to 0..100% of $P_{Nom}$	
9	VMON	AO	Actual voltage	0...10 V or. 0...5 V correspond to 0..100% of $U_{Nom}$	Accuracy < 0.2% at $I_{Max} = +2\text{ mA}$ Short-circuit-proof against AGND
10	CMON	AO	Actual current	0...10 V or. 0...5 V correspond to 0..100% of $I_{Nom}$	
11	AGND	POT	Analog ground		For -SEL, -MON, VREF signals
12	R-ACTIVE	DI	R mode on / off	Off = LOW, $U_{Low} < 1\text{ V}$ On = HIGH, $U_{High} > 4\text{ V}$ On, when unconnected	Voltage range = 0...30 V $I_{Max} = -1\text{ mA}$ bei 5 V $U_{LOW\text{ to HIGH typ.}} = 3\text{ V}$ Rec'd sender: Open collector against DGND
13	REM-SB	DI	DC input OFF (DC input ON) (ACK alarms *****)	Off = LOW, $U_{Low} < 1\text{ V}$ On = HIGH, $U_{High} > 4\text{ V}$ On, when unconnected	Voltage range = 0...30 V $I_{Max} = +1\text{ mA}$ at 5 V Rec'd sender: Open collector against DGND
14	ALARMS 2	DO	Overvoltage alarm	Alarm OV = HIGH, $U_{High} > 4\text{ V}$ No alarm OV = LOW, $U_{Low} < 1\text{ V}$	Quasi open collector with pull-up against $V_{cc}^{**}$ With 5 V on the pin max. flow +1 mA $I_{Max} = -10\text{ mA}$ at $U_{CE} = 0,3\text{ V}$ , $U_{Max} = 30\text{ V}$ Short-circuit-proof against DGND
15	STATUS***	DO	Constant voltage regulation active	CV = LOW, $U_{Low} < 1\text{ V}$ CC/CP/CR = HIGH, $U_{High} > 4\text{ V}$	
			DC input	Off = LOW, $U_{Low} < 1\text{ V}$ On = HIGH, $U_{High} > 4\text{ V}$	

\* AI = Analog Input, AO = Analog Output, DI = Digital Input, DO = Digital Output, POT = Potential

\*\* Internal  $V_{cc}$  approx. 10 V

\*\*\* Only one of both signals possible, the selection can be done via remote configuration

\*\*\*\* Only during remote control

\*\*\*\*\* The error of a set value input adds to the general error of the related value on the DC input of the device

3.5.4.5 Overview of the Sub-D Socket

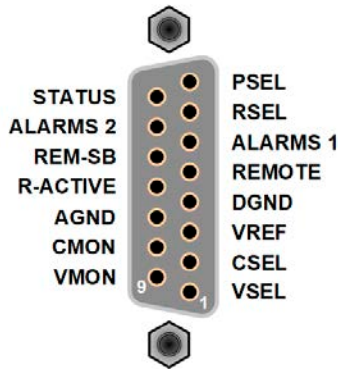

3.5.4.6 Simplified diagram of the pins

	<p><b>Digital Input (DI)</b></p> <p>It requires to use a switch with low resistance (relay, switch, circuit breaker etc.) in order to send a clean signal to the DGND.</p>		<p><b>Analog Input (AI)</b></p> <p>High resistance input (impedance &gt;40 k....100 kΩ) for an operational amplifier circuit.</p>
	<p><b>Digital Output (DO)</b></p> <p>A quasi open collector, realized as high resistance pull-up against the internal supply. The design doesn't allow the pin to be loaded, but to switch signals by sinking current.</p>		<p><b>Analog Output (AO)</b></p> <p>Output from an operational amplifier circuit, only low impedance. See specifications table above.</p>

3.5.4.7 Application examples

a) Switching off the DC input via pin REM-SB

*A digital output, e. g. from a PLC, may be unable to cleanly effect this as it may not be of low enough resistance. Check the specification of the controlling application. Also see pin diagrams above.*

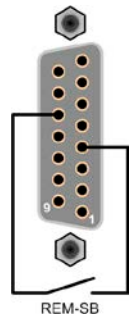

In remote control, pin REM-SB is used to switch the DC input of the device on and off. This function is also available without remote control being active and can on the one hand block the DC input from being switched on in manual or digital remote control and on the other hand the pin can switch the DC input on or off, but not standalone. See below at “Remote control has not been activated”.

It's recommended that a low resistance contact such as a switch, relay or transistor is used to switch the pin to ground (DGND).

Following situations can occur:

- **Remote control has been activated**

During remote control via analog interface, only pin REM-SB determines the states of the DC input, according to the levels definitions in 3.5.4.4. The logical function and the default levels can be inverted by a parameter via software configuration. See EPS Power Control or the included programming guide on USB stick.

*If the pin is unconnected or the connected contact is open, the pin will be HIGH. With parameter “Analog interface Rem-SB” being set to “Normal”, it requests ‘DC input on’. So when activating remote control via pin REMOTE, the DC input would instantly switch on.*



• **Remote control is not active**

In this mode of operation pin REM-SB can serve as lock, preventing the DC input from being switched on by any means. This results in following possible situations:

DC input	+	Level of pin REM-SB	+	Parameter „Analog interface Rem-SB“	→	Behavior
is off	+	HIGH	+	Normal	→	DC input not locked. It can be switched on by pushbutton “On/Off” (front panel) or via command from digital interface.
		LOW	+	Inverted		
	+	HIGH	+	Inverted	→	DC input locked. It can't be switched on by pushbutton “On/Off” (front panel) or via command from digital interface.
		LOW	+	Normal		

In case the DC input is already switched on, toggling the pin will switch the DC input off, similar to what it does in analog remote control:

DC input	+	Level of pin REM-SB	+	Parameter „Analog interface Rem-SB“	→	Behavior
is on	+	HIGH	+	Normal	→	DC input remains on, nothing is locked. It can be switched on or off by pushbutton or digital command.
		LOW	+	Inverted		
	+	HIGH	+	Inverted	→	DC input will be switched off and locked. Later it can be switched on again by toggling the pin. During lock, pushbutton or digital command can delete the request to switch on by pin.
		LOW	+	Normal		

**b) Remote control of current and power.**

Requires remote control to be activated (pin REMOTE = LOW)

The set values PSEL and CSEL are generated from, for example, the reference voltage VREF, using potentiometers for each. Hence the electronic load can selectively work in current limiting or power limiting mode. According to the specification of max. 5 mA load for the VREF output, potentiometers of at least 10 kΩ must be used.

The voltage set value VSEL is directly connected to AGND (ground) and therefore has no influence on constant current or power operation.

If the control voltage is fed in from an external source it's necessary to consider the input voltage ranges for set values (0...5 V or 0...10 V).



*Use of the input voltage range 0...5 V for 0...100% set value halves the effective resolution.*

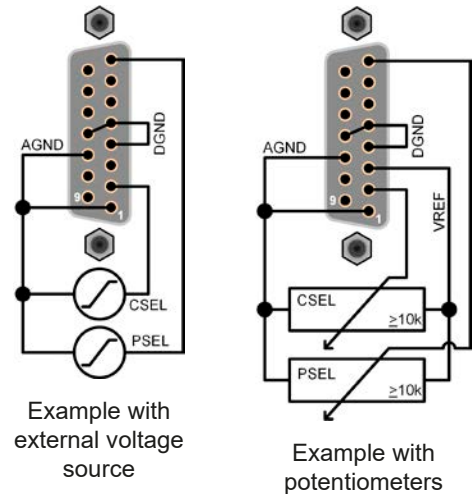

**c) Reading actual values**

The AI provides the DC input values as current and voltage monitor. These can be read using a standard multimeter or similar.

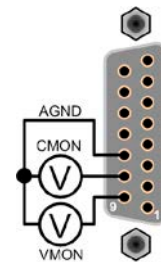

## 3.6 Alarms and monitoring

### 3.6.1 Definition of terms

The device signalizes alarms (see „3.3. Alarm conditions“) via the front LED “Error” and as readable status via digital and analog interface. When running the device as Slave as part of a master-slave system, the alarm is also reported to the master and if the master is a model with display (different series), the alarm is indicated there as well. Basically, device alarms will switch off the DC input, primarily in order to protect the connected source and secondarily to protect the device itself.

Monitoring or supervision is also available in form of user-definable events. The configuration of alarm thresholds and events can only be done via any of the digital interfaces.

### 3.6.2 Device alarm and event handling

#### Important to know:



- The current drained from a switching power supply or similar sources can be much higher than expected due to capacities on the source’s output, even if the source is current limited, and might thus trigger the overcurrent shutdown OCP or the overcurrent event OCD of the electronic load, in case these supervision thresholds are adjusted to too sensitive levels
- When switching off the DC input of the electronic load while a current limited source still supplies energy, the output voltage of the source will rise immediately and due to response and settling times in effect, the output voltage can have an overshoot of unknown level which might trigger the overvoltage shutdown OVP or overvoltage supervision event OVD, in case these thresholds are adjusted to too sensitive levels

A device alarm incident will usually lead to DC input switch-off and the front LED “Error” is lit to make the user aware. Some alarms must be acknowledged. While the device is in digital remote control from a master device, all alarms are acknowledged on the master unit. After acknowledging the alarm on the master, the LED “Error” on the alarm causing slave unit should go off.

For all other situations, the front button “On / Off” or a specific command sent via digital interface in remote control is used to acknowledge alarms.

#### ► How to acknowledge an alarm (during manual control)

1. In case the DC input is switched off and the LED “Error” is lit, use button “On / Off”.
2. The LED should go off and with another push on “On / Off”, the DC input could be switched on again. If the LED remains lit, the alarm cause could still be present.

In order to acknowledge an alarm during analog remote control, see „3.5.4.2. Acknowledging device alarms“. To acknowledge in digital remote, refer to the external documentation “Programming ModBus & SCPI”.

Some device alarms, specifically their thresholds, are configurable via EPS **Power Control** software or custom tools:

Alarm	Meaning	Description	Range	Indication
<b>OVP</b>	<b>OverVoltage Protection</b>	Triggers an alarm as soon as the DC input voltage reaches the defined OVP threshold. The DC input will be switched off..	0 V...1.03*U <sub>Nom</sub>	LED “Error”, analog & digital interfaces
<b>OCP</b>	<b>OverCurrent Protection</b>	Triggers an alarm as soon as the DC input current reaches the defined OCP threshold. The DC input will be switched off..	0 A...1.1*I <sub>Nom</sub>	
<b>OPP</b>	<b>OverPower Protection</b>	Triggers an alarm as soon as the DC input power reaches the defined OPP threshold. The DC input will be switched off..	0 W...1.1*P <sub>Nom</sub>	

These device alarms can't be configured and are based on hardware:

Alarm	Meaning	Description	Indication
<b>PF</b>	<b>Power Fail</b>	AC supply over- or undervoltage. Triggers an alarm if the AC supply is out of specification or when the device is cut from supply, for example when switching it off with the power switch. The DC input will be switched off.	LED "Error", analog & digital interfaces
<b>OT</b>	<b>OverTemperature</b>	Triggers an alarm if the internal temperature exceeds a certain limit. The DC input will be switched off.	LED "Error", analog & digital interfaces
<b>MSP</b>	<b>Master-Slave Protection</b>	Triggers an alarm if the master of an initialised master-slave system loses contact to any slave unit or if a slave has not yet been initialised by the master. The DC input will be switched off. The alarm can be cleared by either deactivating master-slave mode or reinitialising the MS system.	LED "Error", digital interfaces

### 3.6.2.1 User defined events

The monitoring functions of the device can be configured for user defined events. By default, events are deactivated (action = NONE). Contrary to device alarms, the events only work while the DC input is switched on. It means, for instance, that you can't detect undervoltage (UVD) anymore after switching the DC input off and the voltage is still sinking.

The following events can be configured independently and can, in each case, trigger the actions NONE, SIGNAL, WARNING or ALARM:

Action	Impact
<b>NONE</b>	User defined event is disabled.
<b>SIGNAL/WARNING</b>	On reaching the condition which triggers the event with action <b>SIGNAL</b> or <b>WARNING</b> a bit in the status register of the device will be set. That register can be read via USB. With this series, actions <b>SIGNAL</b> and <b>WARNING</b> are equal.
<b>ALARM</b>	On reaching the condition which triggers the event with action <b>ALARM</b> a bit in the status register of the device will be set and the DC input will be switched off. Both conditions can be read via USB from the status register.

Event	Meaning	Description	Range
<b>UVD</b>	<b>UnderVoltage Detection</b>	Triggers an event if the input voltage falls below the defined threshold.	0 V... $U_{Nom}$
<b>OVD</b>	<b>OverVoltage Detection</b>	Triggers an event if the input voltage exceeds the defined threshold.	0 V... $U_{Nom}$
<b>UCD</b>	<b>UnderCurrent Detection</b>	Triggers an event if the input current falls below the defined threshold.	0 A... $I_{Nom}$
<b>OCD</b>	<b>OverCurrent Detection</b>	Triggers an event if the input current exceeds the defined threshold.	0 A... $I_{Nom}$
<b>OPD</b>	<b>OverPower Detection</b>	Triggers an event if the input power exceeds the defined threshold.	0 W... $P_{Nom}$

As soon as an event is set up with an action other than "NONE" while the DC input is still switched on, it can immediately occur and switch the DC input off. It's thus recommended to configure events only while the DC input is switched off.



**3.7 Other applications**

**3.7.1 Two quadrants operation (2QO)**

**3.7.1.1 Introduction**

This kind of operation refers to the use of a source, in this case a power supply from a compatible series (see section „1.9.9. “Share” connector”) and a sink, in this case a series EL 9000 B 2Q electronic load. The “2Q” in the series name points to the primary function of the models in this series, i.e. to work in two-quadrants operation where they play a secondary role, being controlled by a power supply over the so-called Share bus. This bus is an analog connection that determines the voltage level and thus the input current of the sink. Other parameters, which are also required for correct operation, have to be adjusted by the user via the available digital interfaces, at least for the 2Q model.

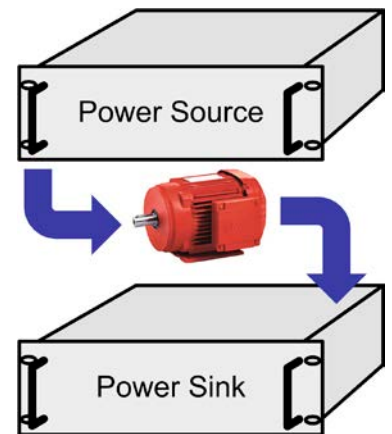

With the Share bus connection in effect the source and sink work as a combination where both parts act alternately. This allows for a multitude of possible applications, such as charging and discharging batteries as part of an end test in production lines or quickly discharging the typical output capacities of switching power supplies which eventually improves the voltage dynamics.

Other applications may require to operate the sink independently and permanently active on the DC output of the source. This can be done by disconnecting the Share bus. In this mode of operation both units are only connected on the DC side. The sink would then only start to react above a certain voltage threshold, for example in order to clip the regenerated energy of a decelerating motor which could cause an excess voltage which is fed back to the source, the power supply.

The user can decide all the time to either operate the system manually or to remotely control only the power supply device as the driving unit or both devices by PC. It’s recommended to focus on the power supply. Two quadrant operation is only suitable for constant voltage operation (CV).

In situations where one power supply and one electronic load don’t suffice regarding the available power, the units can each be extended by further units with identical ratings in master-slave mode and parallel connection.

Clarification:

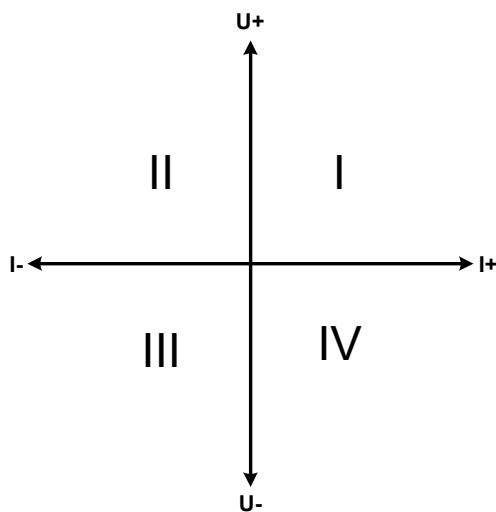

A combination of source and sink can only make use of quadrants I + II, thus the name “two-quadrants operation”. The source (power supply) is hereby assigned to quadrant “I” and the sink (electronic load) to quadrant “II”. This means that only positive voltages are possible.

Considering the system is done with the focus on the E.U.T, the equipment under test. The positive current is generated by the source and flows with positive direction to the E.U.T, while the negative current flows from the E.U.T into the sink.

Typical applications:

- Fuel cells
- Capacitor tests
- Motor driven applications
- Electronic tests where a high dynamic discharge is required.

**3.7.1.2 Connecting devices to a 2QO**

There are a number of possibilities to connect source(s) and sink(s) to make a 2QO:

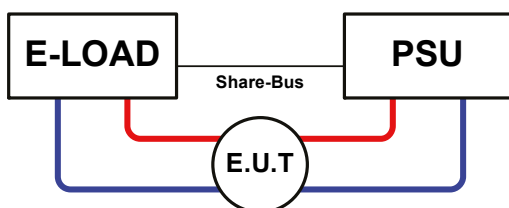

**Configuration A:**

1x e-load and 1x power supply, plus 1x test object (E.U.T).

This is the basic configuration for 2QO. The nominal values of voltage and current of the two devices should match, such as EL 9080-170 B 2Q and PSI 9080-170 3U, but at least the voltage. The system is controlled by the power supply, which has to be set to “Master” in the setup menu, even if there isn’t master-slave operation running.

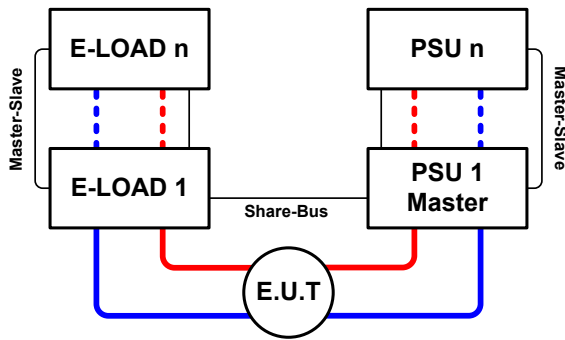
**Configuration B:**

Multiple e-loads and multiple power supplies for increased total performance, plus 1 test object (E.U.T).

The combination of load units and power supply units each create a block, a system with a certain power. Here it's also necessary to match the nominal values of the two systems, like the 80 V DC input of the loads to a max. 80 V DC output of the power supplies. The max. number of 10 units in total can't be exceeded. Regarding the Share bus connection, all e-load units have to be slaves, while one of the PSUs has to be set as master.

**3.7.1.3 Restrictions****Important to know:**

- As long as an electronic load is connected to a driving power supply via Share bus it can't limit its voltage level anymore. The often required limit, such as when discharging batteries, must then be carefully adjusted with correct setting of the power supply.
- The Share bus can't work anymore correct if either the power supply is powered off or fails. The load would then continue to work, but would not receive a stable regulation signal anymore. In such situation only supervision features like UVD (see „3.6.2.1. User defined events“) can protect, for example, a battery from being deeply discharged.
- The Share bus will regulate to “0 V” for an electronic load if the DC output of a driving power supply is switched off. It means, correct operation and voltage level control is only given as long as the DC output remains switched on.

**3.7.1.4 Settings on the devices**

Settings for master-slave also affect the Share bus. For correct 2QO operation, all involved load units must be slaves on the Share bus. This is achieved by setting the master-slave mode to OFF or SLAVE, depending on if there is digital master-slave in use or not. For the one load that is master (setting: MASTER) in the master-slave system the additional parameter “PSI/ELR system” has to be activated, when using an EL 9000 B HP model as master. When using an EL 9000 B 2Q model as master, the activation is done with ModBus register 652 respectively the corresponding SCPI command via remote configuration.

On any of the power supplies, you need activate master-slave mode and set it to MASTER, unless it's already the master unit of a master-slave system over digital MS bus. Refer to the documentation of the power supply for further information.

For safety of the connected E.U.T / D.U.T and to prevent damage, we recommend to adjust supervision thresholds like OVP/OVD on power supplies (master) resp. UVD on electronic load (slaves) to appropriate levels, which will then switch off the DC output resp. the DC input in case of excess.

**3.7.1.5 Application example**

Constant current charging and discharging of a battery with 24 V/400 Ah, using the wiring example in configuration A.

- Power supply PSI 9080-120 2U with:  $I_{Set} = 40 \text{ A}$  as charging current (typ. 1/10 of capacity),  $P_{Set} = 3000 \text{ W}$
- Electronic load EL 9080-170 B 2Q set to:  $I_{Set} = \text{max. discharging current of the battery (eg. 100 A)}$ ,  $P_{Set} = \text{max.}$ , plus probably UVD = 20 V with event type “Alarm” to stop discharging at a certain low voltage threshold
- Assumption: the battery has a voltage of 26 V at test start
- DC inputs resp. DC outputs on all units switched off



*In this combination of devices it's recommended to always switch on the DC output of the source first and then the DC input of the sink.*

**Part 1: Discharging the battery to 24 V**

Setup: Voltage on the power supply set to 24 V, DC output of power supply and DC input of load activated

Reaction: the e-load will load the battery with a max. current of 100 A in order to discharge it to 24 V. The power supply delivers no current at this moment, because the battery voltage is still higher than what is adjusted on the power supply. The load will gradually reduce the input current in order to maintain the battery voltage at 24 V. Once the battery voltage has reached 24 V with a discharge current of approx. 0 A, the voltage will be maintained at this level by charging from the power supply.



*The power supply determines the voltage setting of the load via the Share bus. In order to avoid deep discharge of the battery due to accidentally setting the voltage on the power supply to a very low value, it's recommended to configure the undervoltage detection feature (UVD) of the load, so it will switch off the DC input when reaching minimum allowed discharge voltage. The settings of the load, as given via the Share bus, can't be read from the load's display.*

## **Part 2: Charging the battery to 27 V**

Setup: Voltage on the power supply set to 27 V

Reaction: the power supply will charge the battery with a maximum current of 40 A, which will gradually reduce with increasing voltage as a reaction to the changing internal resistance of the battery. The load absorbs no current at this charging phase, because it's controlled via the Share and set to a certain voltage, which is still higher than the actual battery voltage. Upon reaching 27 V, the power supply will deliver only the current needed to maintain the battery voltage.

### 3.7.2 Series connection



Series connection is not a permissible operating method for electronic loads and must not be installed or operated under any circumstances!

### 3.7.3 Parallel operation in master-slave (MS)

Apart from the primary function of this series, to work in a two-quadrants operation driven by a power supply, the loads can also be used as slave devices as part of a master-slave system of multiple loads. Because the 2Q can only be configured via remote access, it would be useful to pick a master unit from series EL 9000 B HP. All 2Q models have a matching model in the HP series. Both can be used to build master-slave system with up to 16 units and up to 38.4 kW of total power.

Multiple devices of same kind and model can be connected in parallel in order to create a system with higher total current and hence higher power. For true master-slave operation, the units have to be connected with their DC inputs, their master-slave bus and their Share bus.

The master-slave bus is a digital bus which makes the system work as one big unit regarding adjusted values, actual values and status.

The Share bus will dynamically balance the units in their internal current regulation, especially if the master unit runs a function like sine wave etc. In order for this bus to work correctly, at least the DC minus poles of all units have to be connected, because DC minus is the reference for the Share bus.

#### 3.7.3.1 Restrictions

Compared to normal operation of a single device, master-slave operation has some limitations:

- The MS system reacts differently to alarm situations (see below in 3.7.3.6)
- Using the Share bus makes the system reacts as dynamically as possible, but it's still not as dynamic as single unit operation

#### 3.7.3.2 Wiring the DC inputs

The DC input of every unit in the parallel operation is simply connected to the next unit using cables with cross section according to the maximum current and with short as possible length. Alternatively, u-shaped copper bars could be mounted.

#### 3.7.3.3 Wiring the Share bus

The Share bus is wired from unit to unit with an ideally twisted pair of cables with non-critical cross section. We recommend to use 0.5 mm<sup>2</sup> to 1 mm<sup>2</sup>.



- The Share bus is poled. Take care for correct polarity of the wiring!
- In order for the Share bus to work correctly it requires at least to connect all DC minus inputs of the devices



*A max. of 16 units can be connected via Share bus.*

#### 3.7.3.4 Wiring and set-up of the master-slave bus

The master-slave connectors are built-in and must first be connected via network cables (≥CAT3, patch cable) and then MS can be configured via remote control with commands or software. The following applies:

- A maximum 16 units can be connected via the bus: 1 master and up to 15 slaves.
- Only devices of same kind, i.e. electronic load to electronic load, and of the same model, such as EL 9080-170 B 2Q to EL 9080-170 B 2Q or to EL 9080-170 B HP.
- Units at the end of the bus must be terminated (see below)



The master-slave bus (RS485) must not be wired using crossover cables!

Later operation of the MS system implies:

- the master unit displays, if a master model with display is used, or makes available to be read by the remote controller, the sum of the actual values of all the units
- the range for setting the values of the master is adapted to the total number of units, thus, if e. g. 5 units each with a power of 2.4 kW are connected together to a 12 kW system, then the master can be set in the range 0...12 kW
- Slaves can't be reconfigured as long as under control by a master unit

## ► How to connect the master-slave bus

1. Switch off all units that are to be connected and connect them together with a network cable (CAT3 or better, not included). It doesn't matter which of the two master-slave connection sockets is connected to the next unit.
2. Also connect all units at the DC side.
3. The two units at the beginning and end of the chain should be terminated, if long connection cables (> 0.5 m) are used. This is achieved using a 3-pole DIP switch which is positioned on the back side of the unit next to the MS connectors.





Now the master-slave system must be configured on each unit. It's recommended to configure first all the slave units and then the master unit. The 2Q models of this series can only be configured by software, so the step-by-step guide below is for the use of the included software EPS Power Control (Windows only). Custom software can be used as well. **Furthermore it's presumed that a master unit with display is used**, such as one from EL 9000 B HP series. The 2Q series models are capable of running as master as well, but then the entire setup and initialization of the units has to be done via software.

## ► Step 1: Configuring all 2Q slave units with EPS Power Control

1. Connect the device via USB cable to the USB port **on the rear side** and install the drivers, if necessary.
2. Start the software and drag 'n drop the device symbol onto the app "Settings".
3. Switch to tab "Master-slave" and from the drop-down list select "Slave". The address setting can be ignored, because this series uses auto-enumeration.

The slave is then configured for master-slave. Repeat the procedure for all other slave units.

## ► Step 2: Configuring the master unit

1. Enter **MENU** then GENERAL SETTINGS and press  until reaching page **MASTER-SLAVE MODE**.
2. Specify the unit as master with touch area . A warning requester will appear which has to be acknowledged with OK, otherwise the change will be reverted.
3. Accept the settings with the touch area  and return to the main page.

## ► Step 3: Initializing the master

The master unit and the entire master-slave system still need to be initialized. In the main screen of the master unit, after quitting the setting menus, a pop-up will appear presenting the result of the first init run:



Tapping **Initialize** repeats the search for slaves in case the detected number of slaves is less than expected, the system has been reconfigured, not all slave units are already set as **Slave** or the cabling/termination is still not OK. The result window shows the number of slaves, plus the total current, power and resistance of the MS system.

In case there are no slaves found, the master will still initialize the MS system with only itself.



*The initializing process of the master and the master-slave system will, as long as MS mode is still activated, be repeated each time the units are powered. The initialization can be repeated anytime via the MENU in GENERAL SETTINGS.*



### 3.7.3.5 Operating the master-slave system

2Q models don't indicate their status as "Slave" or "Master" separately. Only when being "Slave", the LED "Remote" on the front is lit. As slave they can no longer be controlled manually or remotely, neither via the analog nor via digital interfaces. They can, if needed, be monitored by reading actual values and status.

The display on the master unit changes after initialization and all set values are reset. The master now displays the set and actual values of the total system. Depending on the number of units, the total current and power will multiply. The following applies:

- The master can be treated as a standalone unit
- The master shares the set values across the slaves and controls them
- The master is remotely controllable via the analog or digital interfaces
- All settings for the set values U, I and P (monitoring, settings limits etc.) will be adapted to the new total values
- All initialized slaves will reset any limits ( $U_{\min}$ ,  $I_{\max}$  etc.), supervision thresholds (OVP, OPP etc.) and event settings (UCD, OVD etc.) to default values, so these don't interfere the control by the master. As soon as these values are modified on the master, they are transferred 1:1 to the slaves. Later, during operation, it might occur that a slave causes an alarm or event rather than the master, due to imbalanced current or slightly faster reaction.
- If one or more slaves report an device alarm, this will be displayed on the master and must be acknowledged there so that the slave(s) can continue operation. If the alarm had caused the DC input to be switched off then it can be switched on again on the master unit once the alarm has been acknowledged
- Loss of connection to any slave will result in shutdown of all DC inputs, as a safety measure, and the master will report this situation in the display with a pop-up "Master-slave safety mode" (short: MSS). Then the MS system has to be re-initialized, either with or without re-establishing connection to the disconnected unit(s).
- All units, even the slaves, can be externally shut down on the DC inputs using the pin REM-SB of the analog interface. This can be used as some kind of emergency off, where usually a contact (maker or breaker) is wired to this pin on all units in parallel.

### 3.7.3.6 Alarms and other problem situations

Master-slave operation, due to the connection of multiple units and their interaction, can cause additional problem situations which do not occur when operating individual units. For such occurrences the following regulations have been defined:

- Generally, if the master loses connection to any slave, it will generate an MSP (master-slave protection) alarm, pop up a message on the screen and switch off its DC input. The slaves will fall back to single operation mode, but also switch off their DC input. The MSP alarm can be deleted by either initializing the master-slave system again. This can be done either in the MSP alarm pop-up screen or in the MENU of the master or via remote control. Alternatively, the alarm is also cleared by deactivating master-slave on the master unit
- If the DC part of one or more slave units is switched off due to defect, overheating etc., the whole MS system shuts down the power consumption and human interaction is required.
- If one or more slave units are cut from AC supply (power switch, blackout, supply undervoltage) while the master is still running and they come back later, they're not automatically initialized and included again in the MS system. Then the initialization has to be repeated.
- If the DC input of the master unit is switched off due to a defect or overheating, then the total master-slave system can take no input power and the DC input of all slaves is automatically switched off, too.
- If the master unit is switched off on the AC side (power switch, supply undervoltage) and comes back later, it will automatically initialize the MS system again, finding and integrating all active slaves. In this case, MS can be restored automatically.
- If accidentally multiple or no units are defined as master the master-slave system can't be initialized.

In situations where one or multiple units generate a device alarm like OV, PF or OT following applies:

- Any alarm of a slave is indicated on the slave's front panel by LED "Error" and on the master's display
- If multiple alarms happen simultaneously, the master only indicates the most recent one. In this case, the particular alarms can be read from the slave units as alarm counter via digital interface (rear ports).

### 3.7.3.7 Important to know



*In case one or several units of a parallel system are not going to be used and remain switched off, depending on the number of active units and the dynamics of the operation it may become necessary to disconnect the inactive units from the Share bus, because even when not powered the units can have a negative impact on the Share bus due to their impedance.*

## 4. Service and maintenance

### 4.1 Maintenance / cleaning

The device needs no maintenance. Cleaning may be needed for the internal fans, the frequency of cleanse is depending on the ambient conditions. The fans serve to cool the components which are heated by the inherent dissipation of energy. Heavily dirt filled fans can lead to insufficient airflow and therefore the DC input would switch off too early due to overheating or possibly lead to defects.

Cleaning the internal fans can be performed with a vacuum cleaner or similar. This can be done from the outside, but for best results it's recommend to clean the inside too. For this the device needs to be opened.

### 4.2 Fault finding / diagnosis / repair

If the equipment suddenly performs in an unexpected way, which indicates a fault, or it has an obvious defect, this can't and must not be repaired by the user. Contact the supplier in case of suspicion and elicit the steps to be taken.

It will then usually be necessary to return the device to EPS Stromversorgung (with or without warranty). If a return for checking or repair is to be carried out, ensure that:

- the supplier has been contacted and it's clarified how and where the equipment should be sent.
- the device is in fully assembled state and in suitable transport packaging, ideally the original packaging.
- optional extras such as an interface module is included if this is in any way connected to the problem.
- a fault description in as much detail as possible is attached.
- if shipping detination is abroad, the necessary customs papers are attached.

#### 4.2.1 Replacing a defect mains fuse

The device is protected by a fusible which is inside a fuse holder in the AC socket on the rear of the device. The fuse value is readable from the broken fuse or stated in the technical specification (1.8.3). Replace the fuse only with one of same size and rating.

#### 4.2.2 Firmware updates



Firmware updates should only be installed when they can eliminate existing bugs in the firmware in the device or contain new features.

The firmware of the control panel (HMI), of the communication unit (KE) and the digital controller (DR), if necessary, is updated via the rear side USB port. For this the software EPS Power Control is needed which is included with the device or available as download from our website together with the firmware update, or upon request.

However, be advised not to install updates promptly. Every update includes the risk of an inoperable device or system. We recommend to install updates only if...

- an imminent problem with your device can directly be solved, especially if we suggested to install an update during a support case
- a new feature has been added which you definitely want to use. In this case, the full responsibility is transferred to you.

Following also applies in connection with firmware updates:

- Simple changes in firmwares can have crucial effects on the application the devices are use in. We thus recommend to study the list of changes in the firmware history very thoroughly.
- Newly implemented features may require an updated documentation (user manual and/or programming guide, as well as LabView VIs), which is often delivered only later, sometimes significantly later

## 5. Contact and support

### 5.1 Repairs

Repairs, if not otherwise arranged between supplier and customer, will be carried out by EPS Stromversorgung. For this the equipment must generally be returned to the manufacturer. No RMA number is needed. It's sufficient to package the equipment adequately and send it, together with a detailed description of the fault and, if still under guarantee, a copy of the invoice, to the address below.

### 5.2 Contact options

Questions or problems with operation of the device, use of optional components, with the documentation or software, can be addressed to technical support either by telephone or e-Mail.

Headquarter	e-Mail	Telephone
EPS Stromversorgung Alter Postweg 101 86159 Augsburg Germany	Technical support: info@eps-germany.de	Switchboard: +49 821 / 570451-0





