

Operating Guide

ELR 10000 4U

Electronic DC Load with
Energy Recovery



Attention! This document is only valid for devices with firmwares "KE: 2.04", "HMI: 2.05" and "DR: 1.0.4.3" or higher.

Doc ID: ELR1EN
Revision: 02
Date: 05/2021



TABLE OF CONTENTS

1 GENERAL

1.1	About this document	5	2.3.3	Installing the device	33
1.1.1	Retention and use	5	2.3.4	Connection to water supply (WC models) ..	34
1.1.2	Copyright	5	2.3.5	Connection to AC supply	36
1.1.3	Validity	5	2.3.6	Connection to DC loads or DC sources	39
1.1.4	Symbols and warnings	5	2.3.7	Connection of remote sense	40
1.2	Warranty	5	2.3.8	Grounding of the DC input	41
1.3	Limitation of liability	5	2.3.9	Installation of an interface module	41
1.4	Disposal of equipment	6	2.3.10	Connecting the analog interface	41
1.5	Product key	6	2.3.11	Connecting the Share bus	42
1.6	Intended usage	6	2.3.12	Connecting the USB port (rear side)	42
1.7	Safety	7	2.3.13	Initial commission	42
1.7.1	Safety notices	7	2.3.14	Commission after a firmware update or a long period of non-use	42
1.7.2	Responsibility of the user	8			
1.7.3	Responsibility of the operator	8			
1.7.4	User requirements	8			
1.7.5	Alarm signals	9			
1.8	Technical Data	9			
1.8.1	Approved operating conditions	9			
1.8.2	General technical data	9			
1.8.3	Specific technical data (standard 400/480 V models)	10			
1.8.4	Specific technical data (208 V models)	16			
1.8.5	Views	17			
1.8.6	Control elements	23			
1.9	Construction and function	24			
1.9.1	General description	24			
1.9.2	Block diagram	24			
1.9.3	Scope of delivery	25			
1.9.4	Accessories	25			
1.9.5	Options	25			
1.9.6	The control panel (HMI)	26			
1.9.7	USB port (rear side)	29			
1.9.8	Interface module slot	29			
1.9.9	Analog interface	29			
1.9.10	"Share BUS" connector	30			
1.9.11	"Sense" connector (remote sensing)	30			
1.9.12	Master-Slave bus	30			
1.9.13	Ethernet port	31			
1.9.14	Water cooling	31			

2 INSTALLATION & COMMISSIONING

2.1	Transport and storage	32
2.1.1	Transport	32
2.1.2	Packaging	32
2.1.3	Storage	32
2.2	Unpacking and visual check	32
2.3	Installation	32
2.3.1	Safety procedures before installation and use	32
2.3.2	Preparation	33

3 OPERATION AND APPLICATION

3.1	Important notes	43
3.1.1	Personal safety	43
3.1.2	Genera	43
3.2	Operating modes	43
3.2.1	Voltage regulation / Constant voltage	43
3.2.2	Current regulation / constant current / current limiting	43
3.2.3	Power regulation / constant power / power limiting	44
3.2.4	Resistance regulation / constant resistance	44
3.2.5	Dynamic characteristics and stability crite- ria	44
3.3	Alarm conditions	45
3.3.1	Power Fail	45
3.3.2	Overtemperature	45
3.3.3	Overvoltage protection	45
3.3.4	Overcurrent protection	45
3.3.5	Overpower protection	45
3.3.6	Share bus fail	45
3.4	Manual operation	46
3.4.1	Switching on the device	46
3.4.2	Switching the device off	46
3.4.3	Configuration via the menu	46
3.4.4	Adjustment limits	54
3.4.5	Changing the operating mode	54
3.4.6	Manual adjustment of set values	55
3.4.7	Switching the DC input on or off	56
3.4.8	Recording to USB stick (logging)	56
3.4.9	The quick menu	57
3.4.10	The graph	58
3.5	Remote control	59
3.5.1	General	59
3.5.2	Control locations	59
3.5.3	Remote control via a digital interface	59
3.5.4	Remote control via the analog interface	60
3.6	Alarms and monitoring	64
3.6.1	Definition of terms	64

3.6.2	Device alarm and event handling.....	64
3.7	Locking the control panel (HMI)	67
3.8	Locking the “Limits” and “Profiles”	67
3.9	Loading and saving user profiles	68
3.10	The function generator.....	69
3.10.1	Introduction.....	69
3.10.2	General.....	69
3.10.3	Method of operation.....	70
3.10.4	Manual operation	70
3.10.5	Sine wave function.....	71
3.10.6	Triangular function	72
3.10.7	Rectangular function.....	72
3.10.8	Trapezoidal function.....	73
3.10.9	DIN 40839 function	73
3.10.10	Arbitrary function.....	74
3.10.11	Ramp function.....	78
3.10.12	IU table function (XY table).....	78
3.10.13	Battery test function	80
3.10.14	MPP tracking function.....	82
3.10.15	Remote control of the function generator....	85
3.11	Other applications.....	86
3.11.1	Parallel operation in master-slave (MS).....	86
3.11.2	Series connection	89

4 SERVICE AND MAINTENANCE

4.1	Maintenance / cleaning.....	90
4.1.1	Battery replacement.....	90
4.2	Fault finding / diagnosis / repair.....	90
4.2.1	Firmware updates	90
4.3	Calibration	91
4.3.1	Preface	91
4.3.2	Preparation.....	91
4.3.3	Calibration procedure	91

5 CONTACT AND SUPPORT

5.1	General.....	92
5.2	Contact options	92

1. General

1.1 About this document

1.1.1 Retention and use

This document is to be kept in the vicinity of the equipment for future reference and explanation of the operation of the device. This document is to be delivered and kept with the equipment in case of change of location and/or user.

1.1.2 Copyright

Reprinting, copying, also partially, usage for other purposes as foreseen of this manual are forbidden and breach may lead to legal process.



1.1.3 Validity

This manual is valid for the following equipment and its variants:

Model	Article nr.	Model	Article nr.	Model	Article nr.
ELR 10080-1000 4U	33200801	ELR 10500-180 4U	33200804	ELR 11500-60 4U	33200807
ELR 10200-420 4U	33200802	ELR 10750-120 4U	33200805	ELR 12000-40 4U	33200808
ELR 10360-240 4U	33200803	ELR 11000-80 4U	33200806		

1.1.4 Symbols and warnings

Warning and safety notices as well as general notices in this document are shown in a box with a symbol as follows:

	Symbol for a life threatening danger
	Symbol for general safety notices (instructions and damage protection bans) or important information for operation
	<i>Symbol for general notices</i>

1.2 Warranty

EPS Stromversorgung guarantees the functional competence of the applied technology and the stated performance parameters. The warranty period begins with the delivery of free from defects equipment.

Terms of guarantee are included in the general terms and conditions (TOS) of EPS Stromversorgung.

1.3 Limitation of liability

All statements and instructions in this manual are based on current norms and regulations, up-to-date technology and our long term knowledge and experience. The manufacturer accepts no liability for losses due to:

- Usage for purposes other than designed
- Use by untrained personnel
- Rebuilding by the customer
- Technical changes
- Use of not authorized spare parts

The actual delivered device(s) may differ from the explanations and diagrams given here due to latest technical changes or due to customized models with the inclusion of additionally ordered options.

1.4 Disposal of equipment

A piece of equipment which is intended for disposal must, according to European laws and regulations (ElektroG, WEEE) be returned to the manufacturer for scrapping, unless the person operating the piece of equipment or another, delegated person is conducting the disposal. Our equipment falls under these regulations and is accordingly marked with the following symbol:



The device contains a Lithium battery cell. It's located on the HMI board behind the front plate. Disposal of that battery follows the about stated rule or specific local regulations.

1.5 Product key

Decoding of the product description on the label, using an example:

ELR 10080 - 1000 4U xxx

										Options and special versions: WC = Water cooling
										Construction (not always given): 4U = 19" frame with 4 height units
										Maximum current of the device in Ampere
										Maximum voltage of the device in Volt (e. g. "12000" = 2000 V)
										Series: 10 = Series 10000
										Type identification: ELR = Electronic Load Recovery

1.6 Intended usage

The equipment is intended to be used only as a variable voltage and current source or only as a variable current sink. Typical application for a voltage source is DC power supply to any relevant user, including when used as battery charger to test charge various battery types, and for current sinks the replacement of an ohmic resistor by an adjustable electronic DC load in order to load relevant voltage and current sources of any type.



- Claims of any sort due to damage caused by non-intended usage will not be accepted
- All damage caused by non-intended usage is solely the responsibility of the operator

1.7 Safety**1.7.1 Safety notices****Mortal danger - Hazardous voltage**

- **Never touch AC cables or connectors directly after unplugging from mains supply as the danger of electric shock remains!**
- **There can be dangerous potential between DC minus to PE or DC plus to PE due to charged X capacitors, even when the DC input has been disconnected from the source. Never touch PE and any of the DC poles at the same time with bare hands!**
- **Always follow 5 safety rules when working with electric devices:**
 - **Disconnect completely**
 - **Secure against reconnection**
 - **Verify that the system is dead**
 - **Carry out earthing and short-circuiting**
 - **Provide protection from adjacent live parts**
- **Even though the device is a sink and even when the DC input is switched off, the device can generate a small, not loadable voltage (< 2 V) on its DC terminal!**



- The equipment must only be used as intended
- The equipment is only approved for use within the connection limits stated on the product label.
- Do not insert any object, particularly metallic, through the ventilator slots
- Avoid any use of liquids near the equipment. Protect the device from wet, damp and condensation.
- When operating the device as power supply: do not connect loads, particularly low resistance, to the device while the DC output is switched on; sparking may occur which can cause burns as well as damage to the equipment and to the loads.
- When operating the device as electronic load: do not connect power sources to the device while the DC input is switched on; sparking may occur which can cause burns as well as damage to the equipment and to the source.
- ESD regulations must be applied when plugging interface cards or modules into the relative slot
- Interface cards or modules may only be attached or removed after the device is switched off. It's not necessary to open the device.
- Do not connect external power sources with reversed polarity to the DC terminal! The equipment will be damaged, even when completely powered off.
- Never connect external power sources to the DC terminal that can generate a higher voltage than the rated voltage of the device!
- Never insert a network cable which is connected to Ethernet or its components into the master-slave sockets on the rear side of the device!
- Always configure the various protecting features against overcurrent, overpower etc. for sensitive loads to what the target application requires!
- When operating the device as electronic load: always make sure that the energy recovery can feed back the inverted energy and that it does not switch to isolated operation. For situations of isolated operation a supervision device (AIU, grid and plat protection) has to be installed
- It's not allowed to run the device on AC sources such as generators or UPS equipment. It must only be connected to a power grid!

1.7.2 Responsibility of the user

The equipment is in industrial operation. Therefore the operators are governed by the legal safety regulations. Alongside the warning and safety notices in this manual the relevant safety, accident prevention and environmental regulations must also be applied. In particular the users of the equipment:

- must be informed of the relevant job safety requirements
- must work to the defined responsibilities for operation, maintenance and cleaning of the equipment
- before starting work must have read and understood the operating manual
- must use the designated and recommended safety equipment.

Furthermore, anyone working with the equipment is responsible for ensuring that the device is at all times technically fit for use.

1.7.3 Responsibility of the operator

Operator is any natural or legal person who uses the equipment or delegates the usage to a third party, and is responsible during its usage for the safety of the user, other personnel or third parties.

The equipment is in industrial operation. Therefore the operators are governed by the legal safety regulations. Alongside the warning and safety notices in this manual the relevant safety, accident prevention and environmental regulations must also be applied. In particular the operator has to

- be acquainted with the relevant job safety requirements
- identify other possible dangers arising from the specific usage conditions at the work station via a risk assessment
- introduce the necessary steps in the operating procedures for the local conditions
- regularly control that the operating procedures are current
- update the operating procedures where necessary to reflect changes in regulation, standards or operating conditions.
- define clearly and unambiguously the responsibilities for operation, maintenance and cleaning of the equipment.
- ensure that all employees who use the equipment have read and understood the manual. Furthermore the users are to be regularly schooled in working with the equipment and the possible dangers.
- provide all personnel who work with the equipment with the designated and recommended safety equipment

Furthermore, the operator is responsible for ensuring that the device is at all times technically fit for use.

1.7.4 User requirements

Any activity with equipment of this type may only be performed by persons who are able to work correctly and reliably and satisfy the requirements of the job.

- Persons whose reaction capability is negatively influenced by e.g. drugs, alcohol or medication may not operate the equipment.
- Age or job related regulations valid at the operating site must always be applied.



Danger for unqualified users

Improper operation can cause person or object damage. Only persons who have the necessary training, knowledge and experience may use the equipment.

Delegated persons are those who have been properly and demonstrably instructed in their tasks and the attendant dangers.

Qualified persons are those who are able through training, knowledge and experience as well as knowledge of the specific details to carry out all the required tasks, identify dangers and avoid personal and other risks.

All work on electrical equipment may only be performed by qualified electricians.

1.7.5 Alarm signals

The equipment offers various possibilities for signaling alarm conditions, however, not for danger situations. The signals may be optical (on the display as text), acoustic (piezo buzzer) or electronic (pin/status output of an analog interface). All alarms will cause the device to switch off the DC input.

The meaning of the signals is as follows:

Signal OT (OverTemperature)	<ul style="list-style-type: none"> • Overheating of the device • DC input will be switched off • Non-critical
Signal OVP / SOVP (OverVoltage)	<ul style="list-style-type: none"> • Overvoltage shutdown of the DC input due to high voltage entering the device or generated by the device itself due to a defect • Critical! The device could be damaged
Signal OCP (OverCurrent)	<ul style="list-style-type: none"> • Shutdown of the DC input due to excess of the preset limit • Non-critical, protects the source from excessive current consumption
Signal OPP (OverPower)	<ul style="list-style-type: none"> • Shutdown of the DC input due to excess of the preset limit • Non-critical, protects the source from excessive power consumption
Signal PF (Power Fail)	<ul style="list-style-type: none"> • Shutdown of the DC input due to AC undervoltage or defect in the AC section • Critical on overvoltage! AC section could be damaged
Signal MSP (Master-Slave Protection)	<ul style="list-style-type: none"> • Shutdown of the DC input due to communication problems on the master-slave bus • Non-critical
Signal SF (Share Bus Fail)	<ul style="list-style-type: none"> • Shutdown of the DC input due to signal distortion on the Share bus • Non-critical

1.8 Technical Data

1.8.1 Approved operating conditions

- Use only inside dry buildings
- Ambient temperature 0-50°C (32-122 °F)
- Operational altitude: max. 2000 m (6500 ft) above sea level
- Max 80% relative humidity, not condensing

1.8.2 General technical data

Display: Color TFT touch screen with gorilla glass, 5", 800pt x 480pt, capacitive

Controls: 2 rotary knobs with pushbutton function, 1 pushbutton

The nominal values for the device determine the maximum adjustable ranges.

1.8.3 Specific technical data (standard 380/400/480 V models)

30 kW	Model 380/400/480 V		
	ELR 10080-1000	ELR 10200-420	ELR 10360-240
AC supply			
Voltage range (L-L)	380 / 400 / 480 V, ±10%		
Frequency	45 - 66 Hz		
Connection	3ph, PE		
Leak current	≤ 3.5 mA		
Phase current / Inrush current	Max. 49 A		
Efficiency of energy recovery	≤ 94%	≤ 94.2%	≤ 94.6%
Power factor	≈ 0.99		
DC input			
Max. voltage U_{Max}	80 V	200 V	360 V
Max. current I_{Max}	1000 A	420 A	240 A
Max. power P_{Max}	30000 W	30000 W	30000 W
Overvoltage protection range	0...88 V	0...220 V	0...396 V
Overcurrent protection range	0...1100 A	0...462 A	0...264 A
Overpower protection range	0...33000 W	0...33000 W	0...33000 W
Temperature coefficient (Δ/K)	Voltage set values / current set values: 100 ppm		
Capacitance (approx.)	25380 μ F	5400 μ F	1800 μ F
Voltage regulation			
Adjustment range	0...81.6 V	0...204 V	0...367.2 V
Accuracy ⁽¹⁾ (at 23 ± 5 °C / 73±9 °F)	≤ 0.05% U_{Nom}	≤ 0.05% U_{Nom}	≤ 0.05% U_{Nom}
Line regulation at ±10% ΔU_{AC}	≤ 0.02% U_{Nom}	≤ 0.02% U_{Nom}	≤ 0.02% U_{Nom}
Display: Resolution	See section "1.9.6.4. Resolution of the displayed values"		
Display: Accuracy ⁽²⁾	≤ 0.2% U_{Nom}	≤ 0.2% U_{Nom}	≤ 0.2% U_{Nom}
Remote sensing compensation	Max. 5% U_{Nom}	Max. 5% U_{Nom}	Max. 5% U_{Nom}
Load regulation at 0...100% ΔU	≤ 0.05% U_{Nom}	≤ 0.05% U_{Nom}	≤ 0.05% U_{Nom}
Current regulation			
Adjustment range	0...1020 A	0...428.4 A	0...244.8 A
Accuracy ⁽¹⁾ (at 23 ± 5 °C / 73±9 °F)	≤ 0.1% I_{Nom}	≤ 0.1% I_{Nom}	≤ 0.1% I_{Nom}
Line regulation at ±10% ΔU_{AC}	≤ 0.05% I_{Nom}	≤ 0.05% I_{Nom}	≤ 0.05% I_{Nom}
Display: Resolution	See section "1.9.6.4. Resolution of the displayed values"		
Display: Accuracy ⁽²⁾	≤ 0.2% I_{Nom}	≤ 0.2% I_{Nom}	≤ 0.2% I_{Nom}
Load regulation at 0...100% ΔU_{IN}	≤ 0.15% I_{Nom}	≤ 0.15% I_{Nom}	≤ 0.15% I_{Nom}
Power regulation			
Adjustment range	0...30600 W	0...30600 W	0...30600 W
Accuracy ⁽¹⁾ (at 23 ± 5 °C / 73±9 °F)	≤ 0.3% P_{Nom}	≤ 0.3% P_{Nom}	≤ 0.3% P_{Nom}
Line regulation at ±10% ΔU_{AC}	≤ 0.05% P_{Nom}	≤ 0.05% P_{Nom}	≤ 0.05% P_{Nom}
Load reg. at 10-90% $\Delta U_{DC} * \Delta I_{DC}$	≤ 0.75% P_{Nom}	≤ 0.75% P_{Nom}	≤ 0.75% P_{Nom}
Display: Resolution	See section "1.9.6.4. Resolution of the displayed values"		
Display: Accuracy ⁽²⁾	≤ 0.2% P_{Nom}	≤ 0.2% P_{Nom}	≤ 0.2% P_{Nom}
Resistance regulation			
Adjustment range	0.003...5 Ω	0.0165...25 Ω	0.05...90 Ω
Accuracy (at 23 ± 5 °C / 73±9 °F)	≤ 0.3% of max. resistance ± 0.1% of maximum current		
Display: Resolution	See section "1.9.6.4. Resolution of the displayed values"		

(1) Related to the nominal values, the accuracy or error/tolerance defines the maximum deviation between an adjusted value and the actual value on the DC input. Example: a 1000 A model has a min. current accuracy of 0.1% , that is 1 A. When adjusting the current to 300 A, the actual current on the DC input is allowed to differ max. 1 A from the set value, which means it could be between 299 A and 301 A.

(2) The display error adds to the error of the related actual value on the DC input

30 kW	<i>Model 380/400/480 V</i>		
	<i>ELR 10080-1000</i>	<i>ELR 10200-420</i>	<i>ELR 10360-240</i>
Analog interface ⁽¹⁾			
Input signals	Set values (U, I, P, R), DC on/off, resistance on/off, remote control on/off		
Output signals	Actual values (U, I), regulation mode, DC input status, alarms		
Galvanic isolation to the device	Max. 725 V DC	Max. 725 V DC	Max. 1500 V DC
Insulation			
Allowed potential shift (floating voltage) on the DC output:			
Negative DC to PE	±500 V DC	±725 V DC	±1500 V DC
Positive DC to PE	+600 V DC	+1000 V DC	+2000 V DC
AC input <-> PE	2.5 kV DC		
AC input <-> DC input	2.5 kV DC		
Miscellaneous			
Cooling (Standard / Slave)	Temperature controlled fans, front inlet, rear exhaust		
Cooling (WC)	Water		
Ambient temperature	0...50 °C (32...133 °F)		
Storage temperature	-20...70 °C (-4...158 °F)		
Humidity	≤ 80%, not condensing		
Standards	EN 61010-1:2007-11, EN 50160:2011-02 (grid class 2) EN 61000-6-2:2016-05, EN 61000-6-3:2011-09 (radiation class B)		
Overvoltage category	2		
Protection class	1		
Pollution degree	2		
Operational altitude	≤ 2000 m (6500 ft)		
Digital interfaces			
Featured	1x USB and 1x Ethernet for communication, 1x USB-A for data recording, Master-slave		
Slot	Optional: CANopen, Profibus, Profinet, RS232, CAN, EtherCAT, ModBus TCP		
Galvanic isolation from device	Max. 725 V DC	Max. 725 V DC	Max. 1500 V DC
Terminals			
Rear side	Share Bus, DC output, AC supply, remote sensing, analog interface, USB, Ethernet master-slave bus, interface module slot		
Front side	USB for sticks		
Dimensions			
Enclosure (W x H x D)	19" x 4U x 670 mm (26.4")		
Total (W x H x D)	483 x 177 x min. 760 mm (19" x 7" x min. 29.9")		
Weight (standard)	≈ 50 kg (110 lbs)	≈ 50 kg (110 lbs)	≈ 50 kg (110 lbs)
Weight (WC)	≈ 55 kg (121 lbs)	≈ 55 kg (121 lbs)	≈ 55 kg (121 lbs)
Article number (Standard)	33200801	33200802	33200803
Article number (WC)	33250801	33250802	33250803

(1 For technical specifications of the analog interface see "3.5.4.3 Analog interface specification" on page 61

30 kW	<i>Model 380/400/480 V</i>		
	<i>ELR 10500-180</i>	<i>ELR 10750-120</i>	<i>ELR 11000-80</i>
AC supply			
Voltage range (L-L)	380 / 400 / 480 V, ±10%		
Frequency	45 - 66 Hz		
Connection	3ph, PE		
Leak current	≤ 3.5 mA		
Phase current / Inrush current	Max. 49 A		
Efficiency of energy recovery	≤ 95.3%	≤ 95.5%	≤ 94.6%
Power factor	≈ 0.99		
DC input			
Max. voltage U_{Max}	500 V	750 V	1000 V
Max. current I_{Max}	180 A	120 A	80 A
Max. power P_{Max}	30000 W	30000 W	30000 W
Overvoltage protection range	0...550 V	0...825 V	0...1100 V
Overcurrent protection range	0...198 A	0...132 A	0...88 A
Overpower protection range	0...33000 W	0...33000 W	0...33000 W
Temperature coefficient (Δ/K)	Voltage set values / current set values: 100 ppm		
Capacitance (approx.)	675 μ F	450 μ F	200 μ F
Voltage regulation			
Adjustment range	0...510 V	0...765 V	0...1020 V
Accuracy ⁽¹⁾ (at 23 ± 5 °C / 73±9 °F)	≤ 0.05% U_{Nom}	≤ 0.05% U_{Nom}	≤ 0.05% U_{Nom}
Line regulation at ±10% ΔU_{AC}	≤ 0.02% U_{Nom}	≤ 0.02% U_{Nom}	≤ 0.02% U_{Nom}
Display: Resolution	See section "1.9.6.4. Resolution of the displayed values"		
Display: Accuracy ⁽²⁾	≤ 0.2% U_{Nom}	≤ 0.2% U_{Nom}	≤ 0.2% U_{Nom}
Remote sensing compensation	Max. 5% U_{Nom}	Max. 5% U_{Nom}	Max. 5% U_{Nom}
Load regulation at 0...100% ΔU	≤ 0.05% U_{Nom}	≤ 0.05% U_{Nom}	≤ 0.05% U_{Nom}
Current regulation			
Adjustment range	0...183.6 A	0...122.4 A	0...81.6 A
Accuracy ⁽¹⁾ (at 23 ± 5 °C / 73±9 °F)	≤ 0.1% I_{Nom}	≤ 0.1% I_{Nom}	≤ 0.1% I_{Nom}
Line regulation at ±10% ΔU_{AC}	≤ 0.05% I_{Nom}	≤ 0.05% I_{Nom}	≤ 0.05% I_{Nom}
Display: Resolution	See section "1.9.6.4. Resolution of the displayed values"		
Display: Accuracy ⁽²⁾	≤ 0.2% I_{Nom}	≤ 0.2% I_{Nom}	≤ 0.2% I_{Nom}
Load regulation at 0...100% ΔU_{IN}	≤ 0.15% I_{Nom}	≤ 0.15% I_{Nom}	≤ 0.15% I_{Nom}
Power regulation			
Adjustment range	0...30600 W	0...30600 W	0...30600 W
Accuracy ⁽¹⁾ (at 23 ± 5 °C / 73±9 °F)	≤ 0.3% P_{Nom}	≤ 0.3% P_{Nom}	≤ 0.3% P_{Nom}
Line regulation at ±10% ΔU_{AC}	≤ 0.05% P_{Nom}	≤ 0.05% P_{Nom}	≤ 0.05% P_{Nom}
Load reg. at 10-90% ΔU_{DC} * ΔI_{DC}	≤ 0.75% P_{Nom}	≤ 0.75% P_{Nom}	≤ 0.75% P_{Nom}
Display: Resolution	See section "1.9.6.4. Resolution of the displayed values"		
Display: Accuracy ⁽²⁾	≤ 0.2% P_{Nom}	≤ 0.2% P_{Nom}	≤ 0.2% P_{Nom}
Resistance regulation			
Adjustment range	0.08...170 Ω	0.2...370 Ω	0.4...650 Ω
Accuracy (at 23 ± 5 °C / 73±9 °F)	≤ 0.3% of max. resistance ± 0.1% of maximum current		
Display: Resolution	See section "1.9.6.4. Resolution of the displayed values"		

(1 Related to the nominal values, the accuracy or error/tolerance defines the maximum deviation between an adjusted value and the actual value on the DC input. Example: a 1000 A model has a min. current accuracy of 0.1% , that is 1 A. When adjusting the current to 300 A, the actual current on the DC input is allowed to differ max. 1 A from the set value, which means it could be between 299 A and 301 A.

(2 The display error adds to the error of the related actual value on the DC input

30 kW	Model 380/400/480 V		
	ELR 10500-180	ELR 10750-120	ELR 11000-80
Analog interface ⁽¹⁾			
Input signals	Set values (U, I, P, R), DC on/off, resistance on/off, remote control on/off		
Output signals	Actual values (U, I), regulation mode, DC input status, alarms		
Galvanic isolation to the device	Max. 1500 V DC		
Insulation			
Allowed potential shift (floating voltage) on the DC output:			
Negative DC to PE	±1500 V DC	±1500 V DC	±1500 V DC
Positive DC to PE	+2000 V DC	+2000 V DC	+2000 V DC
AC input <-> PE	2.5 kV DC		
AC input <-> DC input	2.5 kV DC		
Miscellaneous			
Cooling (Standard / Slave)	Temperature controlled fans, front inlet, rear exhaust		
Cooling (WC)	Water		
Ambient temperature	0...50 °C (32...133 °F)		
Storage temperature	-20...70 °C (-4...158 °F)		
Humidity	≤ 80%, not condensing		
Standards	EN 61010-1:2007-11, EN 50160:2011-02 (grid class 2) EN 61000-6-2:2016-05, EN 61000-6-3:2011-09 (radiation class B)		
Overvoltage category	2		
Protection class	1		
Pollution degree	2		
Operational altitude	≤ 2000 m (6500 ft)		
Digital interfaces			
Featured	1x USB and 1x Ethernet for communication, 1x USB-A for data recording, Master-slave		
Slot	Optional: CANopen, Profibus, Profinet, RS232, CAN, EtherCAT, ModBus TCP		
Galvanic isolation from device	Max. 1500 V DC		
Terminals			
Rear side	Share Bus, DC output, AC supply, remote sensing, analog interface, USB, Ethernet master-slave bus, interface module slot		
Front side	USB for sticks		
Dimensions			
Enclosure (W x H x D)	19" x 4U x 670 mm (26.4")		
Total (W x H x D)	483 x 177 x min. 760 mm (19" x 7" x min. 29.9")		
Weight (standard)	≈ 50 kg (110 lbs)	≈ 50 kg (110 lbs)	≈ 50 kg (110 lbs)
Weight (WC)	≈ 55 kg (121 lbs)	≈ 55 kg (121 lbs)	≈ 55 kg (121 lbs)
Article number (Standard)	33200804	33200805	33200806
Article number (WC)	33250804	33250805	33250806

(1 For technical specifications of the analog interface see "3.5.4.3 Analog interface specification" on page 61

30 kW	<i>Model 380/400/480 V</i>	
	<i>ELR 11500-60</i>	<i>ELR 12000-40</i>
AC supply		
Voltage range (L-L)	380 / 400 / 480 V, ±10%	
Frequency	45 - 66 Hz	
Connection	3ph, PE	
Leak current	≤ 3.5 mA	
Phase current / Inrush current	Max. 49 A	
Efficiency of energy recovery	≤ 95.3%	≤ 95.5%
Power factor	≈ 0.99	
DC input		
Max. voltage U_{Max}	1500 V	2000 V
Max. current I_{Max}	60 A	40 A
Max. power P_{Max}	30000 W	30000 W
Overvoltage protection range	0...1650 V	0...2200 V
Overcurrent protection range	0...66 A	0...44 A
Overpower protection range	0...33000 W	0...33000 W
Temperature coefficient (Δ/K)	Voltage set values / current set values: 100 ppm	
Capacitance (approx.)	75 μ F	50 μ F
Voltage regulation		
Adjustment range	0...1530 V	0...2040 V
Accuracy ⁽¹⁾ (at 23 ± 5 °C / 73±9 °F)	≤ 0.05% U_{Nom}	≤ 0.05% U_{Nom}
Line regulation at ±10% ΔU_{AC}	≤ 0.02% U_{Nom}	≤ 0.02% U_{Nom}
Display: Resolution	See section "1.9.6.4. Resolution of the displayed values"	
Display: Accuracy ⁽²⁾	≤ 0.2% U_{Nom}	≤ 0.2% U_{Nom}
Remote sensing compensation	Max. 5% U_{Nom}	Max. 5% U_{Nom}
Load regulation at 0...100% ΔU	≤ 0.05% U_{Nom}	≤ 0.05% U_{Nom}
Current regulation		
Adjustment range	0...61.2 A	0...40.8 A
Accuracy ⁽¹⁾ (at 23 ± 5 °C / 73±9 °F)	≤ 0.1% I_{Nom}	≤ 0.1% I_{Nom}
Line regulation at ±10% ΔU_{AC}	≤ 0.05% I_{Nom}	≤ 0.05% I_{Nom}
Display: Resolution	See section "1.9.6.4. Resolution of the displayed values"	
Display: Accuracy ⁽²⁾	≤ 0.2% I_{Nom}	≤ 0.2% I_{Nom}
Load regulation at 0...100% ΔU_{IN}	≤ 0.15% I_{Nom}	≤ 0.15% I_{Nom}
Power regulation		
Adjustment range	0...30600 W	0...30600 W
Accuracy ⁽¹⁾ (at 23 ± 5 °C / 73±9 °F)	≤ 0.3% P_{Nom}	≤ 0.3% P_{Nom}
Line regulation at ±10% ΔU_{AC}	≤ 0.05% P_{Nom}	≤ 0.05% P_{Nom}
Load reg. at 10-90% ΔU_{DC} * ΔI_{DC}	≤ 0.75% P_{Nom}	≤ 0.75% P_{Nom}
Display: Resolution	See section "1.9.6.4. Resolution of the displayed values"	
Display: Accuracy ⁽²⁾	≤ 0.2% P_{Nom}	≤ 0.2% P_{Nom}
Resistance regulation		
Adjustment range	0.8...1500 Ω	1.7...2700 Ω
Accuracy (at 23 ± 5 °C / 73±9 °F)	≤ 0.3% of max. resistance ± 0.1% of maximum current	
Display: Resolution	See section "1.9.6.4. Resolution of the displayed values"	

(1 Related to the nominal values, the accuracy or error/tolerance defines the maximum deviation between an adjusted value and the actual value on the DC input. Example: a 1000 A model has a min. current accuracy of 0.1% , that is 1 A. When adjusting the current to 300 A, the actual current on the DC input is allowed to differ max. 1 A from the set value, which means it could be between 299 A and 301 A.

(2 The display error adds to the error of the related actual value on the DC input

30 kW	<i>Model 380/400/480 V</i>	
	<i>ELR 11500-60</i>	<i>ELR 12000-40</i>
Analog interface ⁽¹⁾		
Input signals	Set values (U, I, P, R), DC on/off, resistance on/off, remote control on/off	
Output signals	Actual values (U, I), regulation mode, DC input status, alarms	
Galvanic isolation to the device	Max. 1500 V DC	
Insulation		
Allowed potential shift (floating voltage) on the DC output:		
Negative DC to PE	±1500 V DC	±1500 V DC
Positive DC to PE	+2000 V DC	+2000 V DC
AC input <-> PE	2.5 kV DC	
AC input <-> DC input	2.5 kV DC	
Miscellaneous		
Cooling (Standard / Slave)	Temperature controlled fans, front inlet, rear exhaust	
Cooling (WC)	Water	
Ambient temperature	0...50 °C (32...133 °F)	
Storage temperature	-20...70 °C (-4...158 °F)	
Humidity	≤ 80%. not condensing	
Standards	EN 61010-1:2007-11, EN 50160:2011-02 (grid class 2) EN 61000-6-2:2016-05, EN 61000-6-3:2011-09 (radiation class B)	
Overvoltage category	2	
Protection class	1	
Pollution degree	2	
Operational altitude	≤ 2000 m (6500 ft)	
Digital interfaces		
Featured	1x USB and 1x Ethernet for communication, 1x USB-A for data recording, Master-slave	
Slot	Optional: CANopen, Profibus, Profinet, RS232, CAN, EtherCAT, ModBus TCP	
Galvanic isolation from device	Max. 1500 V DC	
Terminals		
Rear side	Share Bus, DC output, AC supply, remote sensing, analog interface, USB, Ethernet master-slave bus, interface module slot	
Front side	USB for sticks	
Dimensions		
Enclosure (W x H x D)	19" x 4U x 670 mm (26.4")	
Total (W x H x D)	483 x 177 x min. 760 mm (19" x 7" x min. 29.9")	
Weight (standard)	≈ 50 kg (110 lbs)	≈ 50 kg (110 lbs)
Weight (WC)	≈ 55 kg (121 lbs)	≈ 55 kg (121 lbs)
Article number (Standard)	33200807	33200808
Article number (WC)	33250807	33250808

(1 For technical specifications of the analog interface see "3.5.4.3 Analog interface specification" on page 61

1.8.4 Specific technical data (208 V models)

The so-called 208 V models, designated on the type label as "US208V", are derivations from the standard models, intended to be sold on the US or Japan market or places where 208 V three-phase supply is typical. They only differ in a few technical specifications which are listed below. The remaining specifications are listed in 1.8.3. The differences compared to the standard models are in the AC supply and DC power rating.

15 kW	Model 208 V		
	ELR 10080-1000 US208V	ELR 10200-420 US208V	ELR 10360-240 US208V
AC supply			
Voltage range (L-L),	187...228 V AC		
Connection	3ph, PE		
DC input			
Max. power P _{Max}	15000 W	15000 W	15000 W
Overpower protection	0...16500 W	0...16500 W	0...16500 W
Power regulation			
Adjustment range	0...15300 W	0...15300 W	0...15300 W
Article number (US208V)	33208801	33208802	33208803
Article number (US208V + WC)	33258801	33258802	33258803

15 kW	Model 208 V		
	ELR 10500-180 US208V	ELR 10750-120 US208V	ELR 11000-80 US208V
AC supply			
Voltage range (L-L),	187...228 V AC		
Connection	3ph, PE		
DC input			
Max. power P _{Max}	15000 W	15000 W	15000 W
Overpower protection	0...16500 W	0...16500 W	0...16500 W
Power regulation			
Adjustment range	0...15300 W	0...15300 W	0...15300 W
Article number (US208V)	33208804	33208805	33208806
Article number (US208V + WC)	33258804	33258805	33258806

15 kW	Model 208 V	
	ELR 11500-60 US208V	ELR 12000-40 US208V
AC supply		
Voltage range (L-L),	187...228 V AC	
Connection	3ph, PE	
DC input		
Max. power P _{Max}	15000 W	15000 W
Overpower protection	0...16500 W	0...16500 W
Power regulation		
Adjustment range	0...15300 W	0...15300 W
Article number (US208V)	33208807	33208808
Article number (US208V + WC)	33258807	33258808

1.8.5 Views

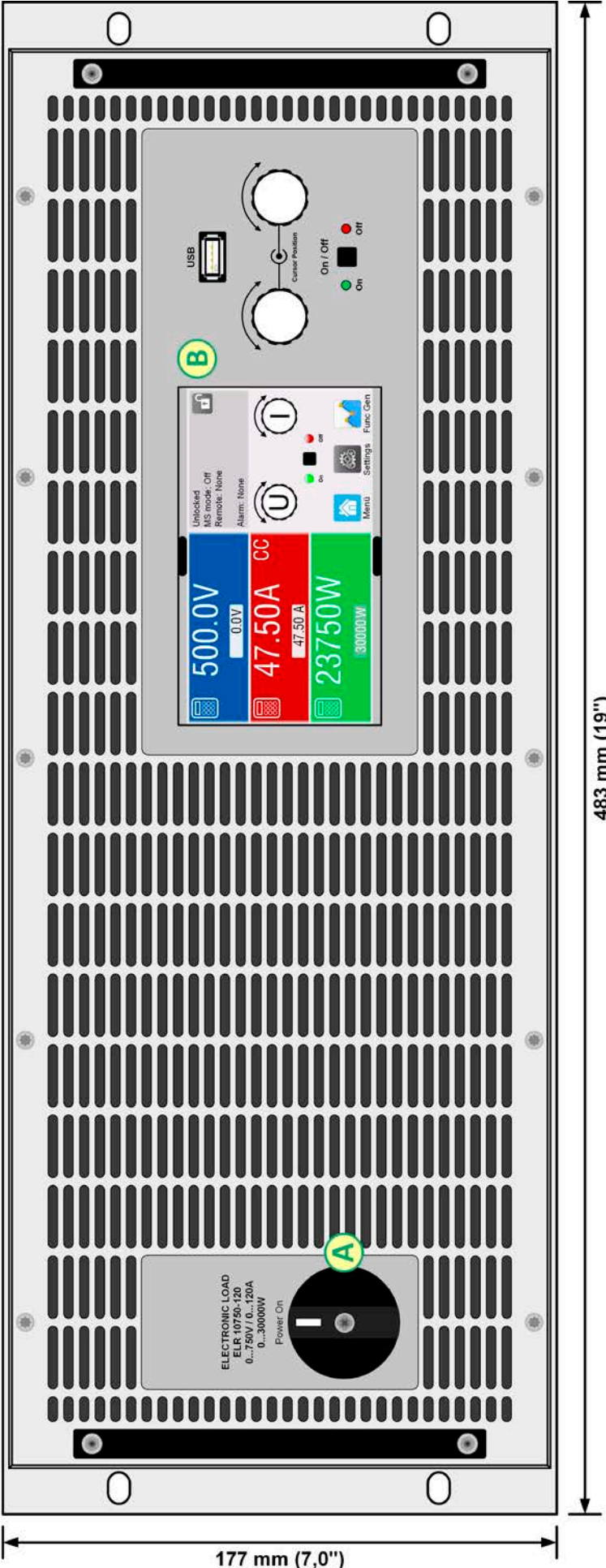

Figure 1 - Front view (standard version)

A - Power switch
B - Control panel

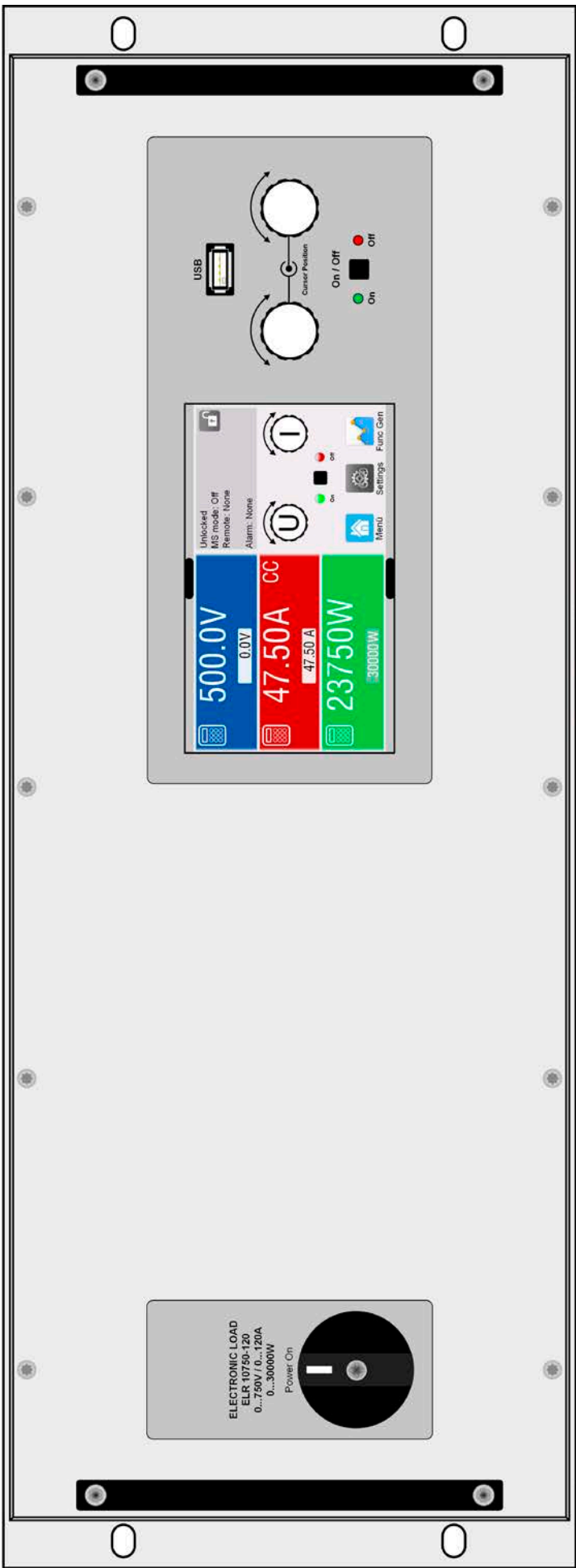
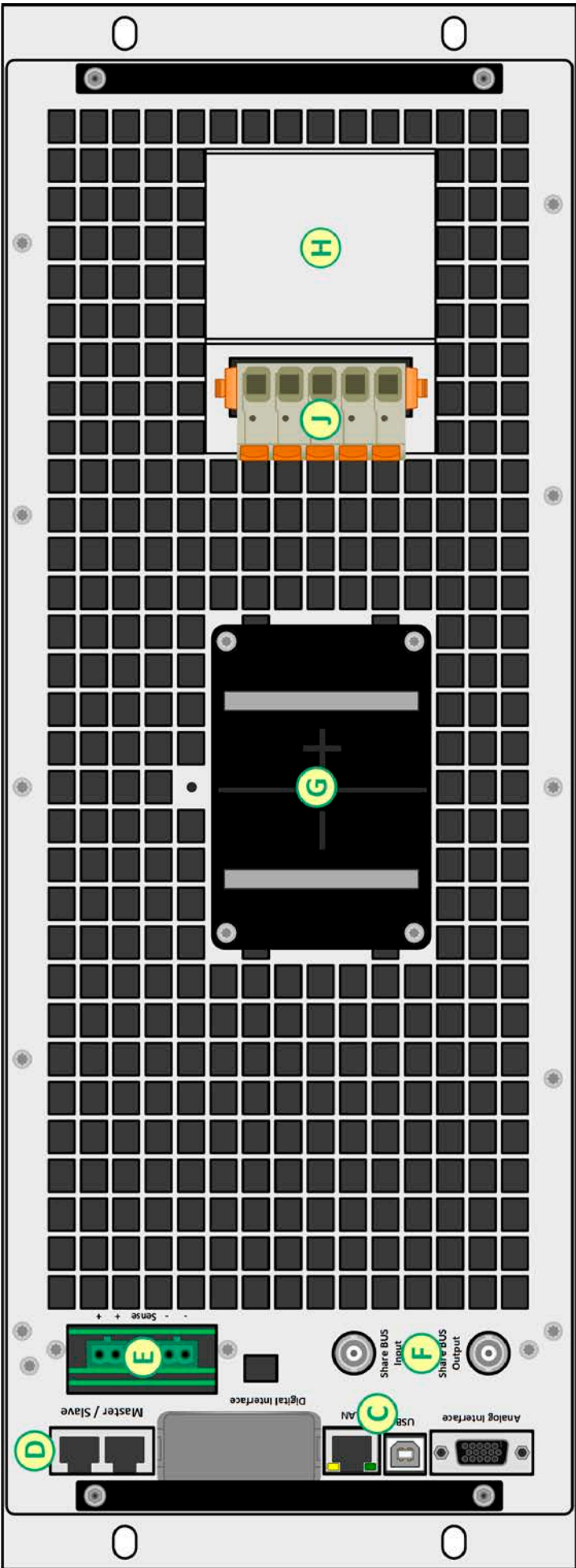

Figure 2 - Front view (water-cooled version)



449 mm (17.7")

Figure 3 - Rear view (standard version)

- C - Control interfaces (digital, analog)
- D - Master-slave bus ports
- E - Remote sensing connection
- F - Share BUS connectors
- G - DC terminal (type 1 shown)
- H - AC input filter
- J - AC plug

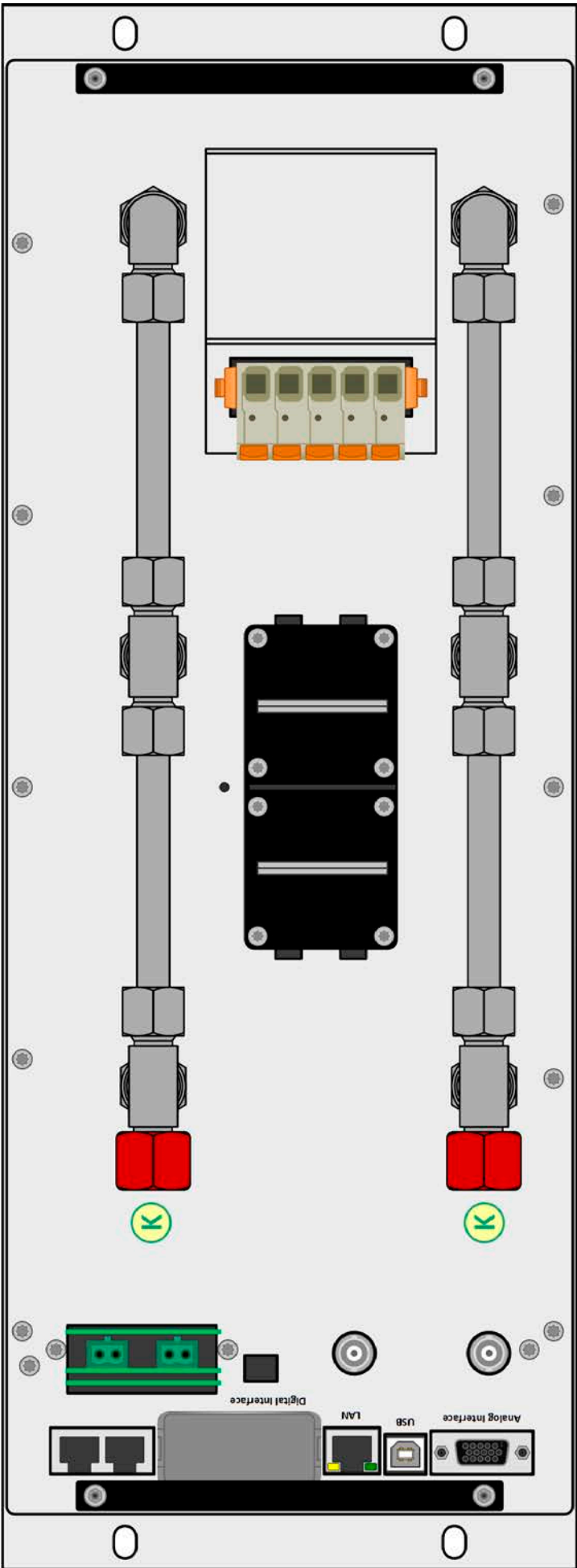

Figure 4 - Rear view (water-cooled version)

K - Water taps (10 mm)

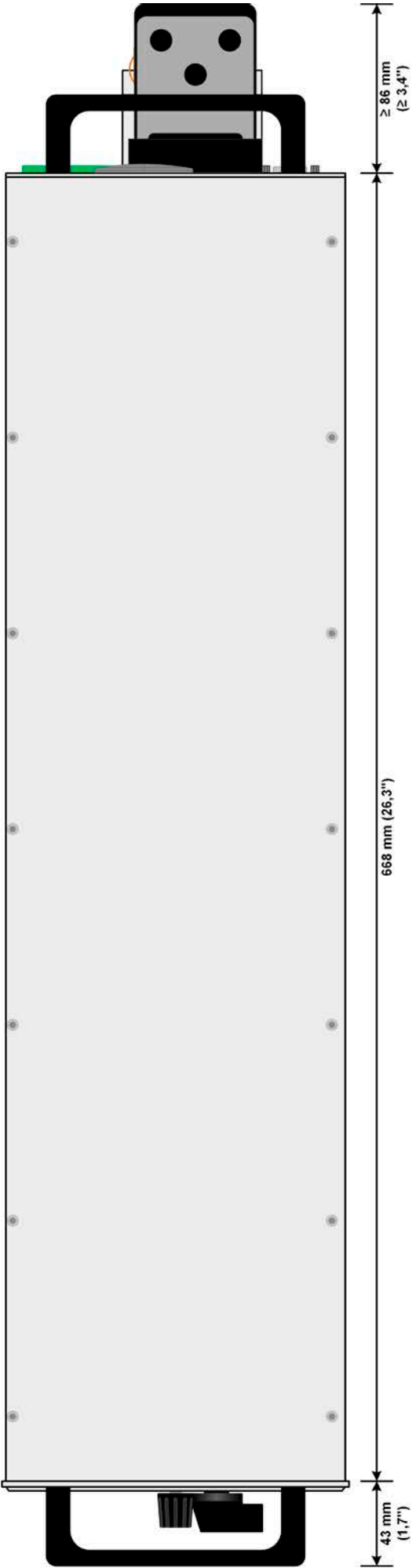

Figure 5 - Side view

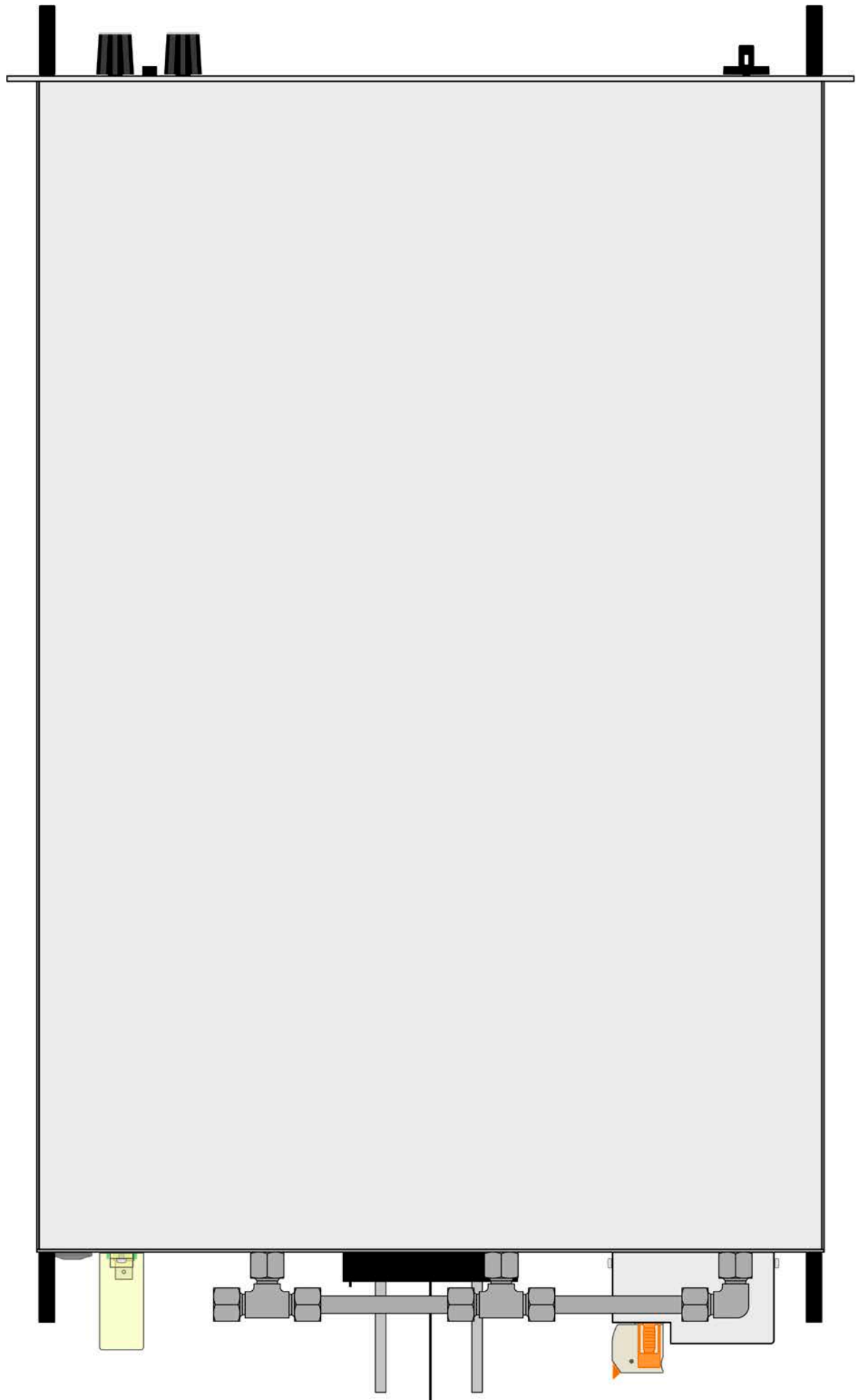

Figure 6 - Top view (example with DC terminal type 1 and water cooling installed)

1.8.6 Control elements

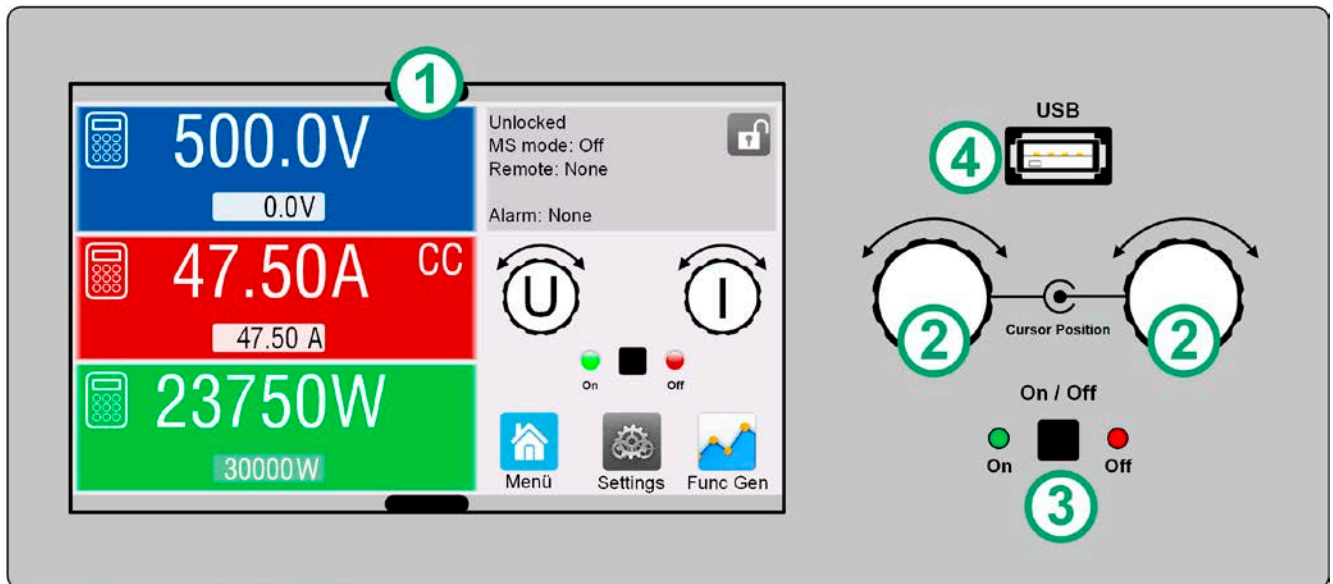

Figure 7- Control Panel

Overview of the elements on the control panel

For a detailed description see section “1.9.6. The control panel (HMI)”.

(1)	<p>Touchscreen display</p> <p>Used for selection and adjustment of set values, call of menus, as well as display of actual values and status. The touchscreen can be operated with the fingers or with a stylus.</p>
(2)	<p>Rotary knob with push button function</p> <p>Left knob (turn): voltage set value adjustment</p> <p>Left knob (push): shift the decimal position (cursor) of the voltage set value</p> <p>Right knob (turn): current, power or resistance set value adjustment</p> <p>Right knob (push): shift the decimal position (cursor) of the currently assigned value</p>
(3)	<p>Button On/Off</p> <p>Used to toggle the DC input between on and off, also used to start a function run. The LEDs “On” and “Off” indicate the state of the DC input, no matter if the device is manually controlled or remotely.</p>
(4)	<p>Port for USB sticks</p> <p>For the connection of standard USB sticks. See section “1.9.6.5. USB port (front side)” for more details.</p>

1.9 Construction and function

1.9.1 General description

The devices of series ELR 10000 4U are energy recovering, switching electronic loads. The recovery or recuperation feature inverts the consumed DC energy with an efficiency of up to 95.5% and feeds it back into the local mains.

Apart from basic functions of electronic loads, set point curves can be generated by the integrated function generator (sine, rectangular, triangular and other curve types). Arbitrary generator curves (up to 99 points) can be saved to and loaded from an USB stick. For industrial component testing, the devices furthermore offer a battery test and an MPP tracking function for solar module tests.

For remote control the devices are provided as standard with USB and Ethernet ports on the rear side, as well as an analog interface. Via optional plug-in interface modules, other digital interfaces such as for RS232, Profibus, ProfiNet, ModBus TCP, CAN, CANopen or EtherCAT can be added. These enable the devices to be connected to standard industrial buses simply by changing or adding a small module. The configuration, if necessary at all, is simple. All interfaces are galvanically isolated from the device's DC and AC parts.

In addition, the devices offer as standard the possibility for parallel connection in so-called Share bus operation for constant current sharing, plus a true master-slave connection with totaling of all actual values is also provided as standard. Operating in this way allows for up to 64 units to be combined to a single system with a total power of up to 1920 kW.

Alternatively to the standard air-cooled version there are also water-cooled available which are usually configured and offered in cabinet systems with a complete water-cooling distribution inside. For DIY water-cooled systems single units can also be obtained upon request.

1.9.2 Block diagram

The block diagram illustrates the main components inside the device and their relationships.

There are digital, microprocessor controlled components (KE, DR, HMI), which can be target of firmware updates.

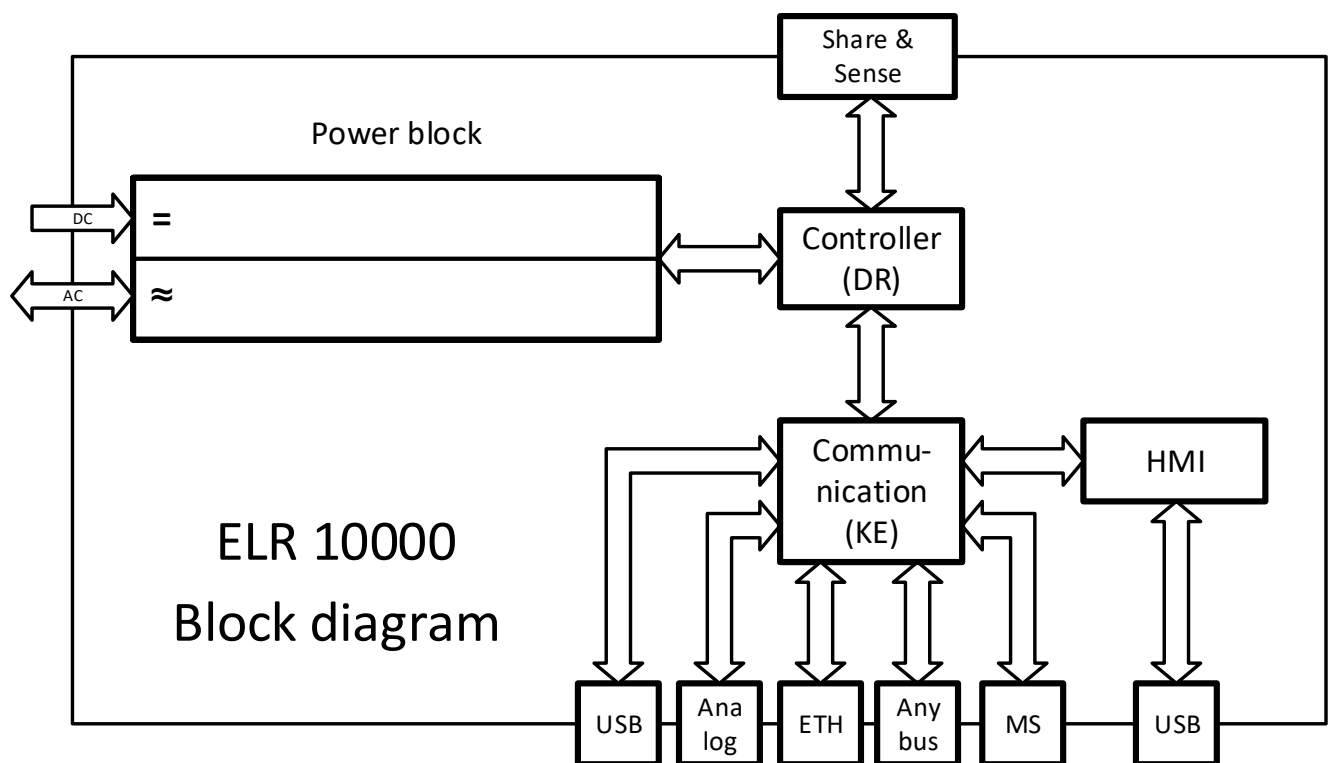

1.9.3 Scope of delivery

- 1 x Electronic load device
- 2 x Remote sensing plugs
- 1 x 1.8 m (5.9 ft) USB cable
- 1 x Set of DC terminal covers (only with models from 360 V)
- 1 x Cover for remote sensing (Sense) terminals
- 1 x USB stick with documentation and software
- 1 x AC connector plug (clamp type)

1.9.4 Accessories

For these devices the following hardware accessories are available:

IF-AB Interface modules	Pluggable and retrofittable, digital interface modules for RS232, CANopen, Profibus, ProfiNet, ModBus TCP, EtherCAT or CAN are available. Details about the interface modules and the programming of the device using those interfaces can be found in separate documentation. It's usually available on the USB stick, which is included with the device, or as PDF download on the manufacturers website.
-----------------------------------	---

For these devices the following software accessories are available:

LICENSE Software licenses	All devices of this series are shipped with a free remote control software for Windows, called EPS Power Control. Besides free-to-use apps this software has other apps like Multi Control, the Graph and the Function Generator, which can be unlocked with a purchasable license code. These three apps are combined under the license "Multi Control". One license per PC required. There is a single license and a 5-pack available, also a 14-day trial license which can be obtained upon request. More information is available in the user manual of this software or on our website.
-------------------------------------	---

1.9.5 Options

These options are usually ordered along with the device, as they are permanently built in or preconfigured during the manufacturing process.

POWER RACKS 19" rack	Racks in various configurations up to 42U as parallel systems are available, or mixed with electronic load devices to create test systems. Further information in our product catalogue, on our website or upon request
WC Water cooling	Replaces the standard cooling blocks of the internal power stages by three interconnected, water cooled blocks with two taps led out for water supply. This options helps to avoid heating up the environment due to exhausted heat which also occurs with an energy recovering device where most of the energy is converted into electricity (recuperation) and supplied back into the power grid. As a side effect, this type of cooling also reduces audible noise.

1.9.6 The control panel (HMI)

The HMI (Human Machine Interface) consists of a display with touchscreen, two rotary knobs, a pushbutton and an USB port.

1.9.6.1 Touchscreen display

The graphic touchscreen display is divided into a number of areas. The complete display is touch sensitive and can be operated by finger or stylus to control the equipment.

In normal operation the left hand side is used to show actual values and set values and the right hand side is used to display status information:

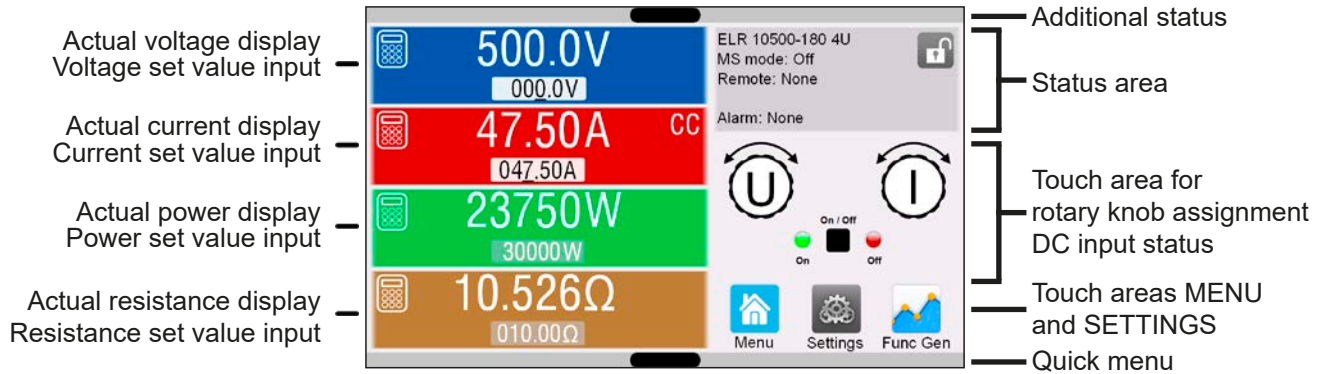

Touch areas may be enabled or disabled:



Black text = Enabled



Grey text = Touch area temporarily disabled

This applies to all touch areas. Some can additionally show a small padlock sign, indicating that the feature is permanently locked, usually due to a specific setting.

• Actual / set values area (left hand side)

In normal operation the actual values (large numbers) and set values (small numbers) for voltage, current, power and resistance on the DC input are displayed. The actual and set of resistance are only displayed while resistance mode is active.

When the DC input is switched on the actual regulation mode is displayed as **CV**, **CC**, **CP** or **CR**, next to the corresponding actual value, as shown in the figure above exemplary with **CC**.

The set values can be adjusted with the rotary knobs next to the display screen or can be entered directly via the touchscreen. When adjusting with the knobs, pushing the knob will select the digit to be changed. Logically, the values are increased by clockwise turning and decreased by anti-clockwise turning.





General display and setting ranges:

Display	Unit	Range	Description
Actual voltage	V	0-125% U_{Nom}	Actual value of the voltage on the DC input
Set value of voltage	V	0-102% U_{Nom}	Set value for limiting the DC voltage
Actual current	A	0.2-125% I_{Nom}	Actual value of the current on the DC input
Set values of current	A	0-102% I_{Nom}	Set value for limiting the DC current
Actual power	W, kW	0-125% P_{Nom}	Actual value of power according to $P = U * I$
Set values of power	W, kW	0-102% P_{Nom}	Set value for limiting DC power
Set value of resistance	Ω	$x^{(1-100\% R_{Max})}$	Set value for the internal resistance
Adjustment limits	ditto	0-102% nom	U-max, I-min etc., related to the physical quantities
Protection settings	ditto	0-110% nom	OVP, OCP, OPP (related to U, I and P)

⁽¹⁾ Lower limit for resistance set value varies. See tables in section 1.8.3

• Status display (upper right)

This area displays various status texts and symbols:

Display	Description
	The HMI is locked
	The HMI is unlocked
Remote:	The device is under remote control from....
Analog	...the built-in analog interface
Ethernet	...the built-in Ethernet interface
USB & others	...the built-in USB port or a plug in interface module
Local	The device has been locked by the user explicitly against remote control
Alarm:	Alarm condition which has not been acknowledged or still exists.
Event:	A user defined event has occurred which isn't yet acknowledged.
MS mode: Master (n SI)	Master-slave mode activated, device is master of n slaves
MS mode: Slave	Master-slave mode activated, device is slave
FG:	Function generator activated, function loaded (only in remote control)
 / 	Data logging to USB stick active or failed

• Area for assigning the rotary knobs and DC input status

The two rotary knobs next to the display screen can be assigned to various functions. This area shows the actual assignments. These can be changed by tapping this area, as long as the panel isn't locked.

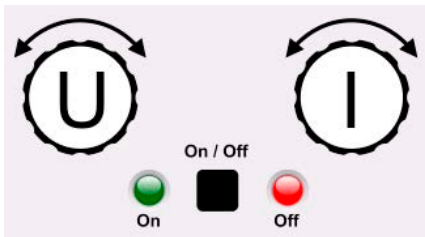

The physical quantities on the depiction of the knob show the current assignment. The left knob is always assigned to the voltage (U), while the right knob can be switched by tapping on the depiction. Furthermore, the DC input status is indicated by two LEDs (green = on).

There are following possible rotary knob assignments:

U I

Left rotary knob: voltage
Right rotary knob: current

U P

Left rotary knob: voltage
Right rotary knob: power

U R

Left rotary knob: voltage
Right rotary knob: resistance
(only with R mode active)

Tapping multiple times will cycle through the 3 assignable set values for this knob. The currently not selected set values can't be adjusted via the rotary knob until the assignment is changed again. Alternatively to tapping on the knob depiction, the assignment can also be changed by tapping the colored set value areas. However, values can be entered directly with a ten-key pad by tapping on the small icon . **This method of entering values allows for big set value steps.**

1.9.6.2 Rotary knobs



As long as the device is in manual operation, the two rotary knobs are used to adjust set values in the main screen. For a detailed description of the individual functions see section "3.4. Manual operation".

1.9.6.3 Pushbutton function of the knobs

The rotary knobs also have a pushbutton function which is used in all value adjustment to move the cursor by rotation like this:

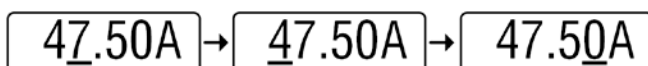

1.9.6.4 Resolution of the displayed values

In the display, set values can be adjusted in fixed increments. The number of decimal places depends on the device model. The values have 4 or 5 digits. Actual and set values always have the same number of digits.

Adjustment resolution and number of digits of set values in the display:

Voltage, OVP, UVD, OVD, U-min, U-max			Current, OCP, UCD, OCD, I-min, I-max			Power, OPP, OPD, P-max			Resistance, R-max		
Nominal	Digits	Min., increment	Nominal*	Digits	Min., increment	Nominal*	Digits	Min., increment	Nominal	Digits	Min., increment
80 V	4	0.01 V	<100 A	4	0.01 A	30000 W	5	1 W	<10 Ω	5	0.0001 Ω
200 V	5	0.01 V	>100 A	4	0.1 A	MS <100 kW	4	0.01 kW	25 Ω / 90 Ω	5	0.001 Ω
360 V	4	0.1 V	≥1000 A	5	0.1 A	MS >100 kW	4	0.1 kW	170 Ω - 650 Ω	5	0.01 Ω
500 V	4	0.1 V	MS ≥3000 A	4	1 A	MS >1000 kW	5	0.1 kW	>1000 Ω	5	0.1 Ω
750 V	4	0.1 V	MS >10000 A	5	1 A						
≥1000 V	5	0.1 V									

* MS = Master-slave

1.9.6.5 USB port (front side)

The frontal USB port is intended for the connection of standard USB sticks and can be used for loading or saving sequences for the arbitrary and the XY generator, as well as for recording measured data during running operation.

USB 2.0 and 3.0 sticks are well supported, though not all sizes. The stick must be **FAT32** formatted. All supported files must be held in a designated folder in the root path of the USB stick in order to be found. This folder must be named **HMI_FILES**, such that a PC would recognize the path G:\HMI_FILES if the drive were to be assigned the letter G. Subfolders are supported. In case there are multiple files of the same type, e. g. such starting with "wave", the device will list the 20 first it can find.

The control panel of the device can read the following file types and names from a stick:

File name	Description	Section
wave_u<arbitrary_text>.csv wave_i<arbitrary_text>.csv	Function generator for an arbitrary function on voltage (U) or current (I) The name must begin with <i>wave_u</i> / <i>wave_i</i> , the rest is user defined.	3.10.10.1
profile_<arbitrary_text>.csv	Previously saved user profile. A max. of 10 files to select from is shown when loading a user profile.	3.9
mpp_curve_<arbitrary_text>.csv	User-defined curve data (100 voltage values) for mode MPP4 of the MPPT function	3.10.14.5
iu<arbitrary_text>.csv	IU table for the XY function generator. The name must begin with <i>iu</i> , the rest can be arbitrary	3.10.12

The control panel of the device can save the following file types and names to an USB stick:

File name	Description	Section
usb_log_<nr>.csv	File with log data recorded during normal operation in all modes. The file layout is identical to the those generated from the Logging feature in EPS Power Control. The <nr> field in the file name is automatically counted up if equally named files already exist in the folder.	3.4.8
profile_<nr>.csv	Saved user profile. The number in the file name is a counter and not related to the actual user profile number in the HMI. A max. of 10 files to select from is shown when loading a user profile.	3.9
wave_u<nr>.csv wave_i<nr>.csv	Sequence point data (here: sequences) of either voltage U or current I from arbitrary function generator	3.10.10.1
battery_test_log_<nr>.csv	File with log data recorded from the battery test function. For a battery test log, data different and/or additional to log data of normal USB logging is recorded.	3.10.13.5
mpp_result_<nr>.csv	Result data from MPP tracking mode 4 in form of a table with 100 data groups (Umpp, Impp, Pmpp)	3.10.14.6

1.9.7 USB port (rear side)

The USB port on the rear side of the device is provided for communication with the device and for firmware updates. The included USB cable can be used to connect the device to a PC (USB 2.0 or 3.0). The driver is delivered with the device and installs a virtual COM port. Details about remote control can be found in form of a programming guide on the included USB stick or on the web site of the manufacturer.

The device can be addressed via this port either using the international standard ModBus RTU protocol or by SCPI language. The device recognizes the message protocol used automatically.

If remote control is in operation the USB port has no priority over either the interface module (see below) or the analog interface and can, therefore, only be used alternatively to these. However, monitoring is always available.

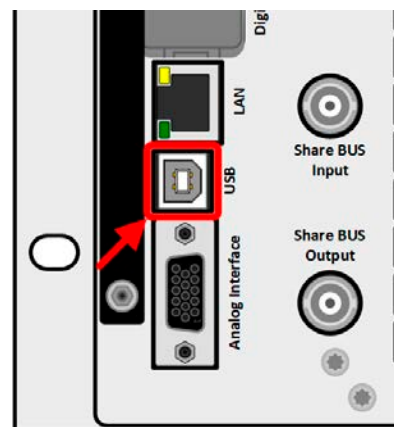

1.9.8 Interface module slot

This slot on the rear side of the device is can receive various modules of the IF-AB interface series. The following options are available:

Article number	Name	Description
35400100	IF-AB-CANO	CANopen, 1x DB9, male
35400101	IF-AB-RS232	RS 232, 1x DB9, male (null modem)
35400103	IF-AB-PBUS	Profibus DP-V1 Slave, 1x DB9, female
35400104	IF-AB-ETH1P	Ethernet, 1x RJ45
35400105	IF-AB-PNET1P	ProfiNET IO, 1x RJ45
35400107	IF-AB-MBUS1P	ModBus TCP, 1x RJ45
35400108	IF-AB-ETH2P	Ethernet, 2x RJ45
35400109	IF-AB-MBUS2P	ModBus TCP, 2x RJ45
35400110	IF-AB-PNET2P	ProfiNET IO, 2x RJ45
35400111	IF-AB-CAN	CAN 2.0 A / 2.0 B, 1x DB9, male
35400112	IF-AB-ECT	EtherCAT, 1x RJ45

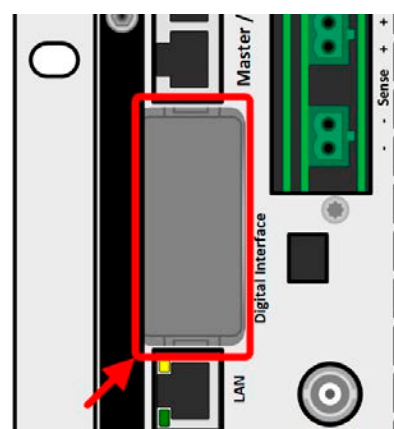

The modules can be installed by the user and hence retrofitted without problem. A firmware update of the device may be necessary in order to recognize and support certain modules.

If remote control is in operation the interface module has no priority over either any other interface and can, therefore, only be used alternately to these. However, monitoring is always available.



Switch your device off before adding or removing modules!

1.9.9 Analog interface

This 15 pole D-sub socket on the rear side of the device is provided for remote control of the device via analog or digital signals.

If remote control is in operation this analog interface can only be used alternately to the digital interface. However, monitoring is always available.

The input voltage range of the set values and the output voltage range of the monitor values, as well as reference voltage level can be switched in the settings menu of the device between 0-5 V and 0-10 V, in each case for 0-100%.

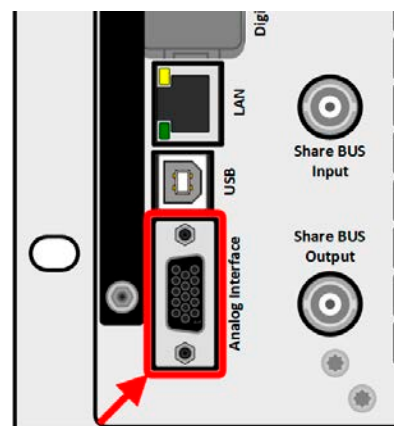

1.9.10 “Share BUS” connector

The two BNC sockets (50 Ω type) labeled “Share BUS” form a digital, passed-through Share bus. This bus is bidirectional and connects the bus master unit via “Share BUS Output” to the next slave unit (“Share BUS Input”) etc., for use in parallel operation, also called master-slave. BNC cables of suitable length can be obtained from us or electronics stores.

Share bus operation requires to connect only identical device models. Following power supply and electronic load series are compatible on this Share bus:

- PSB 10000
- PSB 10000 Slave
- PSBE 10000
- ELR 10000
- PSI 10000

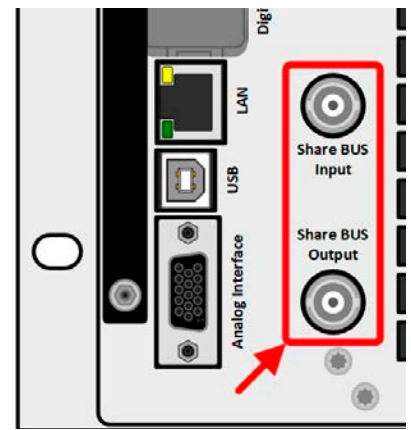

1.9.11 “Sense” connector (remote sensing)

In order to compensate for voltage drops along the DC cables from the external source, the Sense input (2 plugs included in delivery, one each for positive and negative pole) can be connected to the DC output of the external source. The maximum possible compensation is given in the technical specifications.

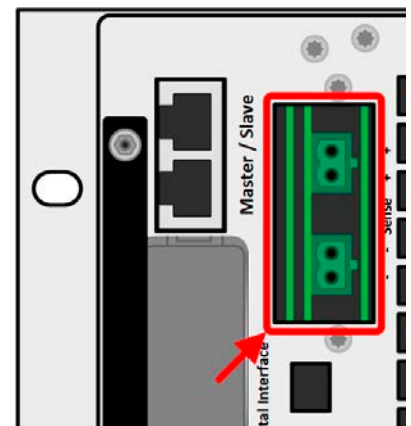

1.9.12 Master-Slave bus

There is a further set of connectors on the rear side of the device, comprising two RJ45 sockets, which enables multiple identical devices to be connected via a digital bus (RS485) in order to create a master-slave system. Connection is made using standard CAT5 cables.

It's recommended to keep the connections as short as possible and to terminate the bus if required. The termination is done via digital switches and activated in the device setup menu in group “Master-Slave”.

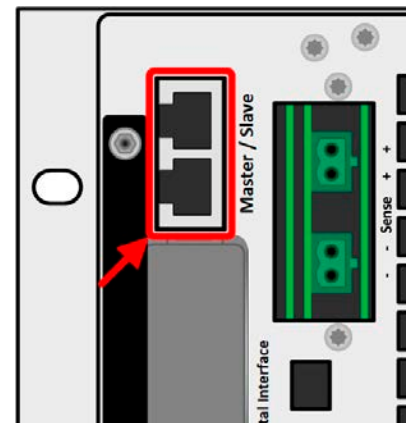

1.9.13 Ethernet port

The RJ45 LAN/Ethernet port on the rear side of the device is provided for communication with the device in terms of remote control or monitoring. The user basically has two options of access:

1. A website (HTTP, port 80) which is accessible in a standard browser via the IP or the host name given for the device. This website offers a configuration page for network parameters, as well as an input box for SCPI commands to control the device remotely by manually entering commands.
2. TCP/IP access via a freely selectable port (except 80 and other reserved ports). The standard port for this device is 5025. Via TCP/IP and the selected port, communication to the device can be established in most of the common programming languages.

Using the Ethernet port, the device can either be controlled by commands from SCPI or ModBus protocol, while automatically detecting the type of message.

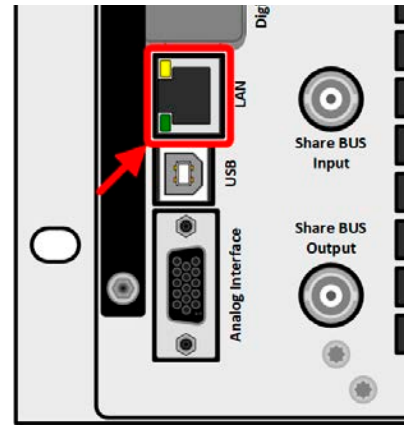

The network setup can be done manually or by DHCP. Transmission speed and duplex mode are on automatic mode. If remote control is in operation the Ethernet port has no priority over any other interface and can, therefore, only be used alternatively to these. However, monitoring is always available.

1.9.14 Water cooling

Contrary to the standard air-cooled versions of the models in this series, water cooling is optionally available. It's built in during the manufacturing process, so retrofitting isn't possible. Cooling the device with water instead of air cooling comes with a few advantages:

- Less ambient noise generated by the device
- Better cooling at higher ambient temperatures
- No direct dissipation of heat into the ambience of the device

However, there also disadvantages:

- The device isn't allowed to run under load without active water flow
- Water flow inside an electronic device includes a higher risk of damage caused by a leak or by condensation of water from air humidity (dewing)

The water taps are located on the rear side of the device, also see the rear view drawing in section 1.8.5. Details about the connection, requirements and use of the water cooling can be found in section 2.3.4.

2. Installation & commissioning

2.1 Transport and storage

2.1.1 Transport



- The handles on the front and rear side of the device are **not** for carrying!
- Because of its weight, transport by hand should be avoided where possible. If unavoidable then only the housing should be held and not on the exterior parts (handles, DC terminal, rotary knobs).
- Do not transport when switched on or connected!
- When relocating the equipment use of the original packing is recommended
- The device should always be carried and mounted horizontally
- Use suitable safety clothing, especially safety shoes, when carrying the equipment, as due to its weight a fall can have serious consequences.

2.1.2 Packaging

It's recommended to keep the complete transport packaging for the lifetime of the device for relocation or return to the manufacturer for repair. Otherwise the packaging should be disposed of in an environmentally friendly way.

2.1.3 Storage

In case of long term storage of the equipment it's recommended to use the original packaging or similar. Storage must be in dry rooms, if possible in sealed packaging, to avoid corrosion, especially internal, through humidity.

2.2 Unpacking and visual check

After every transport, with or without packaging, or before commissioning, the equipment should be visually inspected for damage and completeness using the delivery note and/or parts list (see section "1.9.3. *Scope of delivery*"). An obviously damaged device (e.g. loose parts inside, damage outside) must under no circumstances be put in operation.

2.3 Installation

2.3.1 Safety procedures before installation and use



- The device has a considerable weight. Therefore the proposed location of the equipment (table, cabinet, shelf, 19" rack) must be able to support the weight without restriction.
- When using a 19" rack, rails suitable for the width of the housing and the weight of the device are to be used (see "1.8. *Technical Data*")
- Before connecting to the mains ensure the supply voltage is as shown on the product label. Overvoltage on the AC supply can cause equipment damage.
- Devices of this series feature an energy recovery function which, similar to solar energy equipment, which feeds energy back into the local or public grid. Feedback into the public grid must not be operated without adherence of directives from the local energy supplying company and it must be investigated before the installation or latest before initial commission if there is requirement to install a grid protection device!

2.3.2 Preparation

Mains connection is done via the included 5 pole plug and on the back of the device. Wiring of the plug is at least 4 wire (3x L, PE) of suitable cross section and length. Full configuration with all phases, PE and N is permissible.

For recommendations for a cable cross section see "2.3.5.1. Standard models for 380 / 400 / 480 V". Dimensioning of the DC wiring to the source has to reflect the following:



- The cable cross section should always be specified for at least the maximum current of the device.
- Continuous operation at the approved limit generates heat which must be removed, as well as voltage loss which depends on cable length and heating. To compensate for these the cable cross section should be increased and the cable length reduced.

2.3.3 Installing the device



- Select the location for the device so that the connection to the source is as short as possible.
- Leave sufficient space, at least 30 cm (1 ft), behind the equipment for ventilation (only required for the standard air-cooled version)

A device in a 19" chassis will usually be mounted on suitable rails and installed in 19" racks or cabinets. The depth of the device and its weight must be taken into account. The handles on the front are for sliding in and out of the cabinet. Slots on the front plate are provided for fixing the device (fixing screws not included).

The unacceptable positions, as shown below, are also valid for the vertical mount of the device onto a wall or inside a cabinet. The required air flow would be insufficient. This wouldn't actually apply to water cooled models, but the construction of the entire device isn't made for operation in this position.

Acceptable and unacceptable installation positions (air or water cooled, air cooled shown):

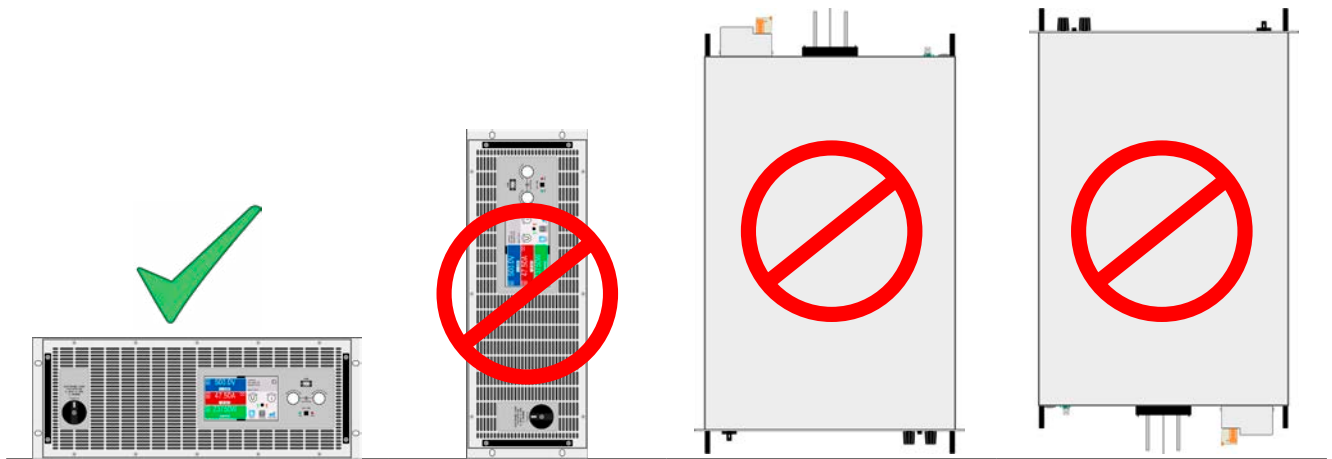

Standing surface

2.3.4 Connection to water supply (WC models)

If already available, the water supply should be connected and any further measures related to water cooling installation should be carried out before the AC supply for the device is connected, let alone the unit is powered. Correct installation and connection, test for **watertightness** and later operation lie in the sole responsibility of the operator or end user.

2.3.4.1 Requirements

Following requirement for the water and the ambience must be met:

- Ambient temperature: max. +50 °C (122 °F)
- Water intake temperature: min. +15 °C (59 °F), max. 33 °C (92 °F)
- Rate of flow: min. 12 l/min (3.17 gal/min)
- Corrosion protection (additive): Ethylene glycol
- Water hardness: soft (calcium carbonate <2 mmol/l)
- Water pressure: min. 1 bar (14 psi), max. 4 bar (58 psi)

2.3.4.2 Connection point

The device has three separate cooling blocks internally, each with its own water pipe. All pipes are led out and connected outside of the device. The water will thus flow through all three pipes in parallel. On the rear of the device are two taps (tee pieces) for water connection:



Tap: tee piece

Thread: M16x1.5

Which one of the two taps is used for intake and outlet is arbitrary. For later use it's only important to have a sufficient amount of water flowing through the pipes, along with a certain water intake temperature.

The hose connection is either directly done on the tee, using the metric thread, or by using a hose tail swivel, for example one from company Schwer Fittings, type SA-DKL90. This swivel is already sealing upon mount, using a 24° metal cone.

2.3.4.3 Operation and supervision

Once the water cooling is installed and running, there is one primary value left to supervise permanently, the so-called dew point. Depending on the temperature of water on the intake in combination with the humidity of ambient air and also the air inside the device water can condensate, i. e. dew inside the device. This must be avoided under all circumstances! It means, it might be required to have regulated water cooling system in order to react to varying ambient conditions.

The dew point is defined in several norms, for instance DIN 4108. The table below defines the dew point (air humidity to water) **in °C in the upper table** and **in °F in the lower table** at specific ambient temperatures and air humidity levels. The intake water temperature must always be higher than the dew point:

Ambient	Relative air humidity in per cent										
	45%	50%	55%	60%	65%	70%	75%	80%	85%	90%	95%
14°C	2.2	3.76	5.1	6.4	7.58	8.67	9.7	10.71	11.64	12.55	13.36
15°C	3.12	4.65	6.07	7.36	8.52	9.63	10.7	11.69	12.62	13.52	14.42
16°C	4.07	5.59	6.98	8.29	9.47	10.61	11.68	12.66	13.63	14.58	15.54
17°C	5	6.48	7.92	9.18	10.39	11.48	12.54	13.57	14.5	15.36	16.19
18°C	5.9	7.43	8.83	10.12	11.33	12.44	13.48	14.56	15.41	16.31	17.25
19°C	6.8	8.33	9.75	11.09	12.26	13.37	14.49	15.47	16.4	17.37	18.22
20°C	7.73	9.3	10.72	12	13.22	14.4	15.48	16.46	17.44	18.36	19.18
21°C	8.6	10.22	11.59	12.92	14.21	15.36	16.4	17.44	18.41	19.27	20.19
22°C	9.54	11.16	12.52	13.89	15.19	16.27	17.41	18.42	19.39	20.28	21.22
23°C	10.44	12.02	13.47	14.87	16.04	17.29	18.37	19.37	20.37	21.34	22.23
24°C	11.34	12.93	14.44	15.73	17.06	18.21	19.22	20.33	21.37	22.32	23.18
25°C	12.2	13.83	15.37	16.69	17.99	19.11	20.24	21.35	22.27	23.3	24.22
26°C	13.15	14.84	16.26	17.67	18.9	20.09	21.29	22.32	23.32	24.31	25.16
27°C	14.08	15.68	17.24	18.57	19.83	21.11	22.23	23.31	24.32	25.22	26.1
28°C	14.96	16.61	18.14	19.38	20.86	22.07	23.18	24.28	25.25	26.2	27.18
29°C	15.85	17.58	19.04	20.48	21.83	22.97	24.2	25.23	26.21	27.26	28.18
30°C	16.79	18.44	19.96	21.44	23.71	23.94	25.11	26.1	27.21	28.19	29.09

Ambient	Relative air humidity in per cent										
	45%	50%	55%	60%	65%	70%	75%	80%	85%	90%	95%
32°C	18.62	20.28	21.9	23.26	24.65	25.79	27.08	28.24	29.23	30.16	31.17
34°C	20.42	22.19	23.77	25.19	26.54	27.85	28.94	30.09	31.19	32.13	33.11
36°C	22.23	24.08	25.5	27	28.41	29.65	30.88	31.97	33.05	34.23	35.06
38°C	23.97	25.74	27.44	28.87	30.31	31.62	32.78	33.96	35.01	36.05	37.03
40°C	25.79	27.66	29.22	30.81	32.16	33.48	34.69	35.86	36.98	38.05	39.11
45°C	30.29	32.17	33.86	35.38	36.85	38.24	39.54	40.74	41.87	42.97	44.03
50°C	34.76	36.63	38.46	40.09	41.58	42.99	44.33	45.55	46.75	47.9	48.98

Ambient	Relative air humidity in per cent										
	45%	50%	55%	60%	65%	70%	75%	80%	85%	90%	95%
58°F	36	38.8	41.2	43.6	45.7	47.7	49.5	51.3	53	54.6	56.1
59°F	37.7	40.4	43	45.3	47.4	49.4	51.3	53.1	54.8	56.4	58
61°F	39.4	42.1	44.6	47	49.1	51.1	53.1	54.8	56.6	58.3	60
63°F	41	43.7	46.3	48.6	50.8	52.7	54.6	56.5	58.1	59.7	61.2
65°F	42.7	45.4	47.9	50.3	52.4	54.4	56.3	58.3	59.8	61.4	63.1
67°F	44.3	47	49.6	52	54.1	56.1	58.1	59.9	61.6	63.3	64.8
68°F	46	48.8	51.3	53.6	55.8	58	59.9	61.7	63.4	65.1	66.6
70°F	47.5	50.4	52.9	55.3	57.6	59.7	61.6	63.4	65.2	66.7	68.4
72°F	49.2	52.1	54.6	57.1	59.4	61.3	63.4	65.2	67	68.6	70.2
74°F	50.8	53.7	56.3	58.8	60.9	63.2	65.1	66.9	68.7	70.5	72.1
76°F	52.5	55.3	58	60.4	62.8	64.8	66.6	68.6	70.5	72.2	73.8
77°F	54	56.9	59.7	62.1	64.4	66.4	68.5	70.5	72.1	74	75.6
79°F	55.7	58.8	61.3	63.9	66.1	68.2	70.4	72.2	74	75.8	77.3
81°F	57.4	60.3	63.1	65.5	67.7	70	72.1	74	75.8	77.4	79
83°F	59	61.9	64.7	66.9	69.6	71.8	73.8	75.8	77.5	79.2	81
85°F	60.6	63.7	66.3	68.9	71.3	73.4	75.6	77.5	79.2	81.1	82.8
86°F	62.3	65.2	68	70.6	74.7	75.1	77.2	79	81	82.8	84.4
90°F	65.6	68.6	71.5	73.9	76.4	78.5	80.8	82.9	84.7	86.3	88.2
94°F	68.8	72	74.8	77.4	79.8	82.2	84.1	86.2	88.2	89.9	91.6
97°F	72.1	75.4	77.9	80.6	83.2	85.4	87.6	89.6	91.5	93.7	95.2
101°F	75.2	78.4	81.4	84	86.6	89	91.1	93.2	95.1	96.9	98.7
104°F	78.5	81.8	84.6	87.5	89.9	92.3	94.5	96.6	98.6	100.5	102.4
113°F	86.6	90	93	95.7	98.4	100.9	103.2	105.4	107.4	109.4	111.3
122°F	94.6	98	101.3	104.2	106.9	109.4	111.8	114	116.2	118.3	120.2

2.3.4.4 Notes

- The water flow should be started prior to powering the device, but at least prior to switching the DC terminal on

2.3.5 Connection to AC supply



- Connection to an AC supply must only be carried out by qualified personnel and the device must always be run directly on a power grid (transformer are permitted) and not on generators or UPS equipment!
- Cable cross section must be suitable for the maximum input current of the device! See tables below. The device should furthermore be fused externally and according to the current rating and cable cross section
- Before plugging the AC plug ensure that the device is switched off by its mains switch!
- Ensure that all regulations for the operation of the device and connection to the public grid of energy back-feeding equipment have been considered and requirements have been met!

2.3.5.1 Standard models for 380 / 400 / 480 V

The device is delivered with a 5 pole AC plug. This plug is connected to 3-phase AC supply, according to the labeling next to the plug (filter housing). Required are following phases:

Rated power	Inputs on AC plug	Supply type	Configuration
30 kW	L1, L2, L3, (N), PE	Three-phase (3P)	Delta



The PE conductor is imperative and must always be wired!



The N conductor of standard cable with 5 conductors isn't required, but can be connected to the free slot on the AC plug.

For the selection of a suitable cable **cross section** the rated AC current of the device and the cable length are decisive. Based on the connection of a **single unit** the table lists the maximum input current and recommended minimum cross section for each phase:

Rated power	L1		L2		L3		PE
	∅	I _{max}	∅	I _{max}	∅	I _{max}	∅
30 kW	10 mm ²	49 A	10 mm ²	49 A	10 mm ²	49 A	10 mm ²

The included connection plug can receive crimped cable ends of up to 16 mm². The longer the connection cable, the higher the voltage loss due to the cable resistance. Therefore the mains cable should be kept as short as possible or have an even bigger cross section. Cables with 4 or 5 conductors can be used. When using a cable with N conductor, it's allowed to clamp it into the spare pin of the AC plug.

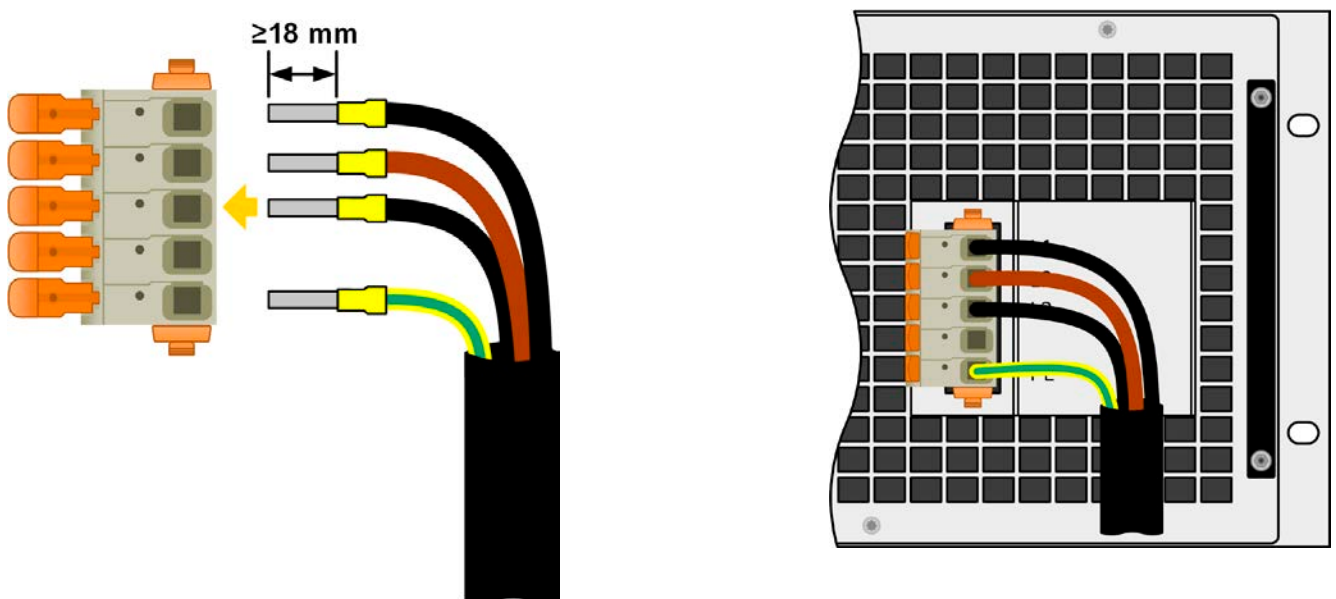

Figure 8 - Example for an AC cable with 4 conductors (european color code, cable not included in delivery)

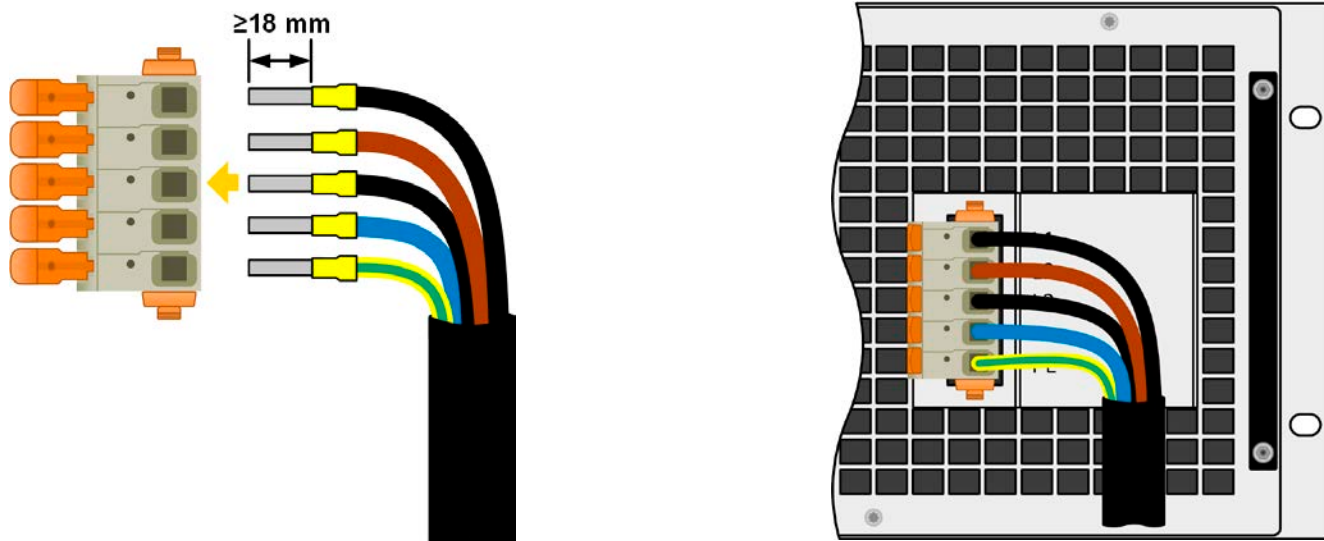



Figure 9 - Example for an AC cable with 5 conductors (european color code, cable not included in delivery)

2.3.5.2 Models for 208 V

The so-called US208V models are also delivered with a 5 pole AC plug. This plug is connected to 3-phase AC supply, according to the labeling next the plug (filter housing). Required are following phases:

Rated power	Inputs on AC plug	Supply type	Configuration
15 kW	L1, L2, L3, (N), PE	Three-phase (3P)	Delta

 The PE conductor is imperative and must always be wired!

 The N conductor, if present in the cable, can be wired to the free slot on the AC plug.

For the wiring **cross section**, the power of the device and the cable length are decisive. The table below shows the maximum output current for each phase, based on the connection of a **standalone unit**:

Nominal power	L1		L2		L3		PE
	∅	I _{max}	∅	I _{max}	∅	I _{max}	∅
15 kW	AWG 8	56 A	AWG 8	56 A	AWG 8	56 A	AWG 8

The included connection plug can receive lose/soldered cable ends of up to 16 mm² (AWG 6). The longer the connection cable, the higher the voltage loss due to the cable resistance. Therefore the mains cables should be kept as short as possible or use bigger cross section. Connection scheme:

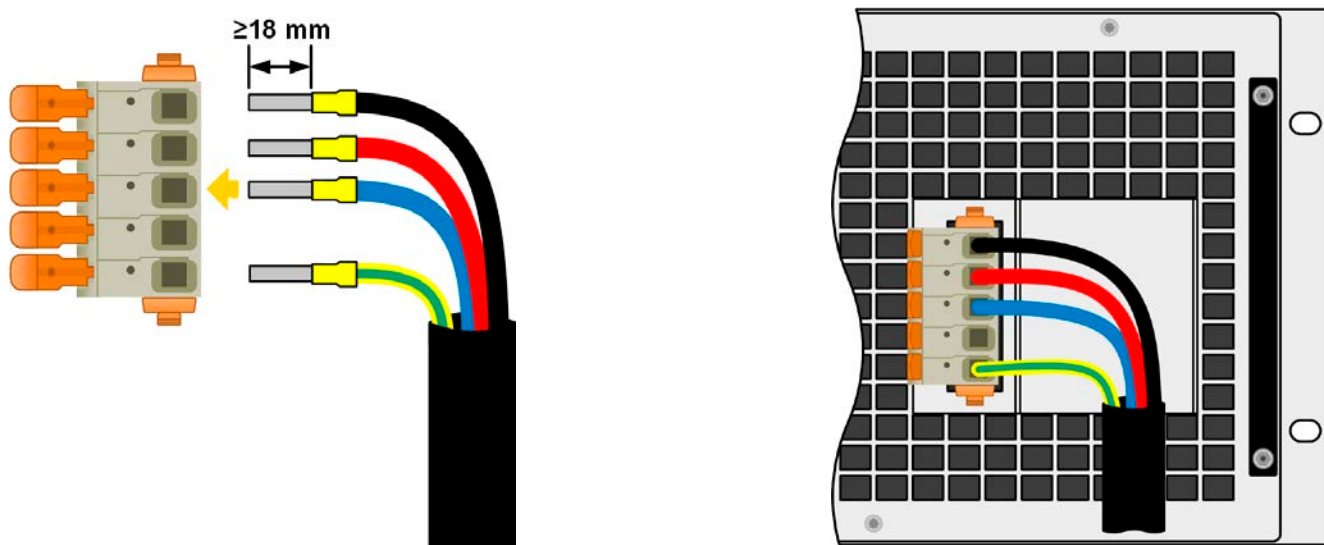
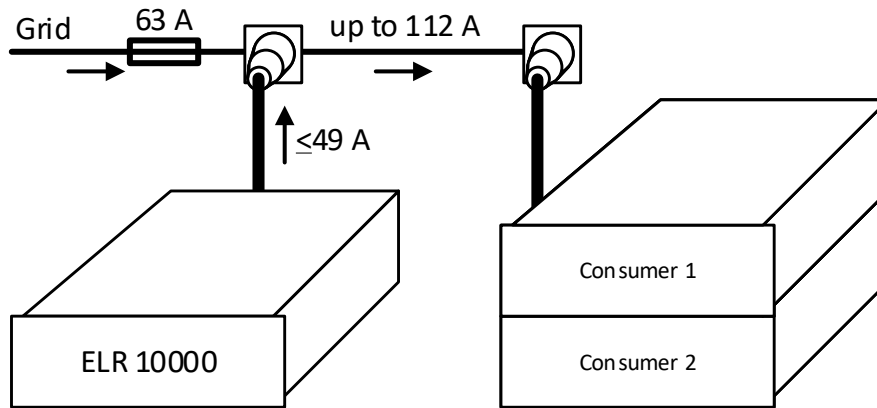

Figure 10 - Example for an AC cable with 4 conductors (US color code, cable not included in delivery)

2.3.5.3 Installation concept for energy recovering devices

An ELR 10000 device converts the consumed DC energy into AC and feeds it back into the local power grid. The generated current adds to the grid current (see schematic below) and this can lead to an overload of the existing electric installation. Considering any two outlets, no matter of what kind they are, there is usually no extra fusing installed in between. In case of a defect in the AC part (i.e. short-circuit) of any consumer device or when there are multiple devices connected which could take a higher power, the total current could flow across wires which are not laid out for this higher current. It could lead to damage or even fire in the wires or connection points.

In order to avoid damages and accidents, the existing installation concept must be taken into regard before installing such recovering devices. Schematic depiction with 1 recovering device and consumers:



When running a higher number of recovering, i. e. energy backfeeding units on the same leg of the installation, the total currents per phase increases accordingly.

2.3.6 Connection to DC loads or DC sources



- In the case of a device with a high nominal DC current and hence a thick and heavy DC connection cable it's necessary to take account of the weight of the cable and the strain imposed on the DC connection. Especially when mounted in a 19" cabinet or similar, where the cable could hang on the DC terminal, a strain reliever should be used.
- Due to the construction, the device will always draw a small current of $\leq 0.1\% I_{Nom}$ when being connected to an external source and while the DC input is switched **off!**



No false polarity protection inside! When connecting sources with false polarity the device will be damaged, also when not powered!

The DC terminal is located on the rear side of the device and **isn't** protected by a fuse. The cross section of the connection cable is determined by the current consumption, cable length and ambient temperature.

For cables **up to 5 m** (16.4 ft) and average ambient temperature **up to 30°C** (86 °F), we recommend:

up to 40 A :	6 mm ²	up to 60 A :	16 mm ²
up to 80 A :	25 mm ²	up to 120 A :	35 mm ²
up to 180 A :	70 mm ²	up to 240 A :	2x 35 mm ²
up to 420 A :	2x 95 mm ²	up to 1000 A :	3x 185 mm ²

per connection pole (multi-conductor, insulated, openly suspended). Single cables of, for example, 70 mm² may be replaced by e.g. 2x 35 mm² etc. If the cables are long then the cross section must be increased to avoid voltage loss and overheating.

2.3.6.1 DC terminal types

The table below shows an overview of the various DC terminals. It's recommended that connection of load cables always utilizes flexible cables with ring lugs.

Type 1: Models up to 200 V	Type 2: Models from 360 V
M10 bolt on a metal rail Recommendation: ring lug with a 11 mm hole	M6 bolt on a metal rail Recommendation: ring lug with a 6.5 mm hole

2.3.6.2 Cable lead and plastic cover

Models from 360 V rating and with type 2 DC terminal have a plastic cover for contact protection included. It should always be installed. There are breakouts so that the supply cable can be laid in various directions.



The connection angle and the required bending radius for the DC cable must be taken into account when planning the depth of the complete device, especially when installing in a 19" cabinet or similar installations.

2.3.7 Connection of remote sense



- Remote sensing is only effective during constant voltage operation (CV) and for other regulation modes the sense input should be disconnected, if possible, because connecting it generally increases the oscillation tendency
- The cross section of the sense cables is noncritical. Recommendation for cables up to 5 m (16.4 ft): 0.5 mm²
- Sense cables shouldn't be twisted, but laid close to the DC cables, i. e. Sense- cable close to DC- cable to the load etc. to damp or avoid possible oscillation. If necessary, an additional capacitor should be installed at the load/consumer to eliminate oscillation
- The "+" of sense must be connected to "+" at the source and "-" of sense to "-" at the source, otherwise the sense input could be damaged. For an example see Figure 11 below.
- In master-slave operation, the remote sensing must only be connected to the master unit
- The dielectric strength of the sense wires must always at least match the DC voltage rating!

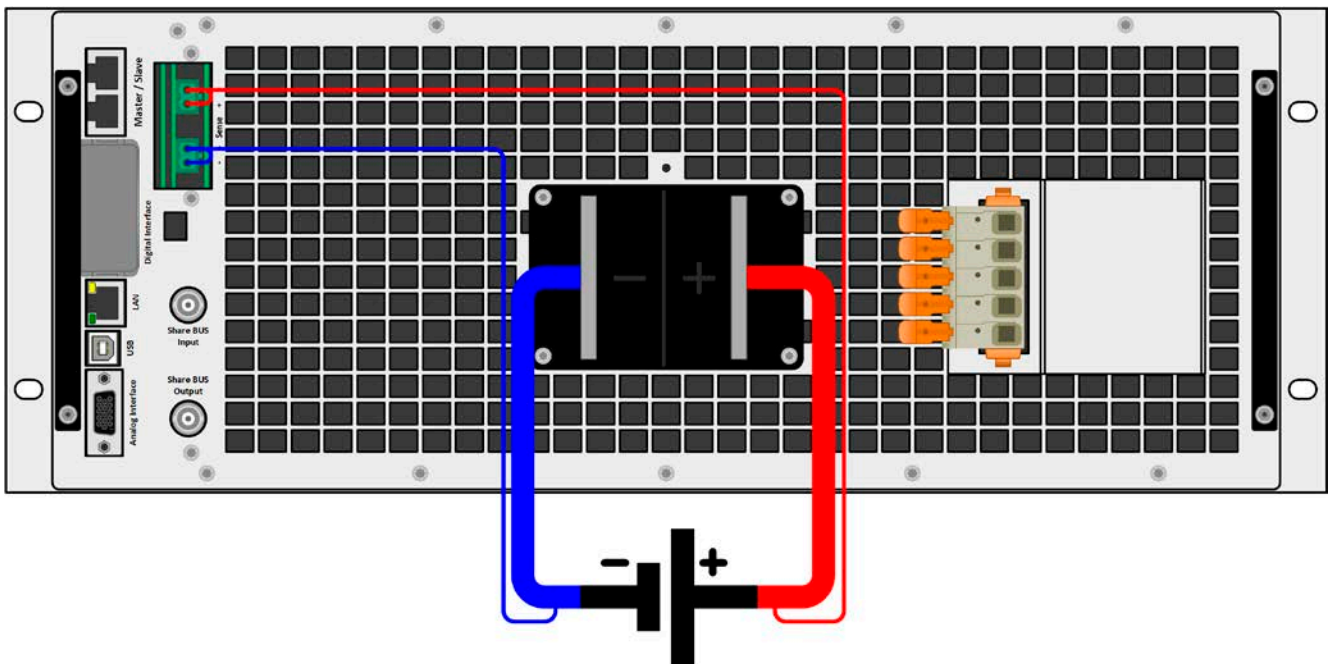
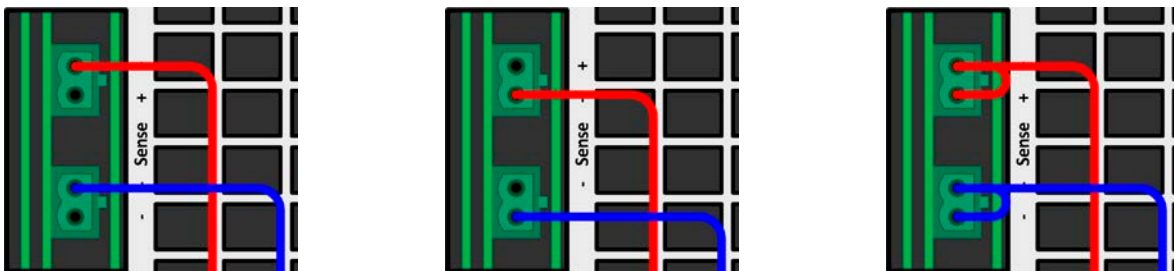

Figure 11 - Example for remote sensing wiring

Allowed connection schemes of the sense connectors:



2.3.8 Grounding of the DC input

Grounding one of the DC input poles is permissible, but causes potential shift against PE on the opposite pole. Because of insulation, there is a max. allowed potential shift defined for the DC terminal poles, which depends on the device model. Refer to "1.8.3. Specific technical data (standard 400/480 V models)" for details.

2.3.9 Installation of an interface module

The optionally obtainable interface modules can be retrofitted by the user and are exchangeable with each other. The settings for the currently installed module vary and need to be checked and, if necessary, corrected on initial installation and after module exchange.



- Common ESD protection procedures apply when inserting or exchanging a module.
- The device must be switched off before insertion or removal of a module
- Never insert any other hardware other than an interface module into the slot
- If no module is in use it's recommended that the slot cover is mounted in order to avoid internal dirtying of the device and changes in the air flow (standard models with air-cooling)

Installation steps:

1.

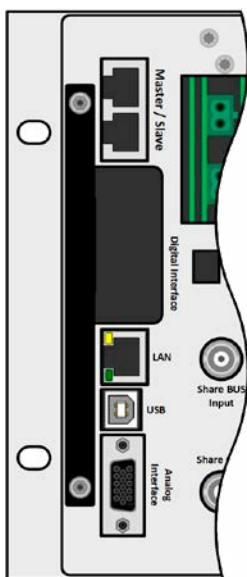

Remove the slot cover. If needed, use a screw driver.

2.

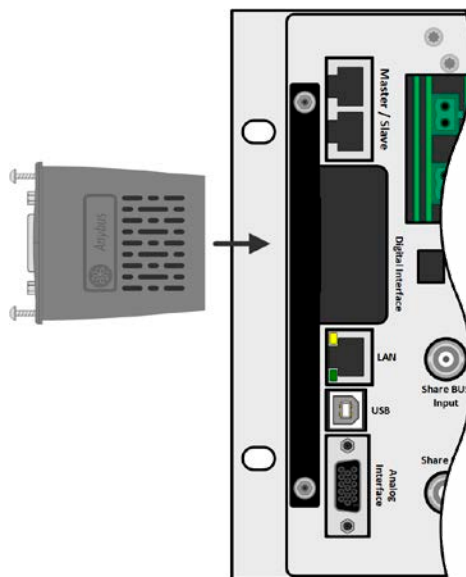

Insert the interface module into the slot. The shape ensures correct alignment.

When inserting take care that it's held as close as possible to a 90° angle to the rear wall of the device. Use the green PCB which you can recognize on the open slot as guide. At the end is a socket for the module.

On the bottom side of the module are two plastic nibs which must click into the green board (PCB) so that the module is properly aligned on the rear wall of the device.

3.

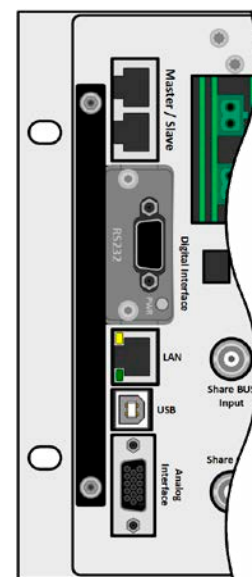

The screws (Torx 8) are provided for fixing the module and should be fully screwed in. After installation, the module is ready for use and can be connected.

Removal follows the reverse procedure. The screws can be used to assist in pulling out the module.

2.3.10 Connecting the analog interface

The 15 pole connector (type: D-sub, VGA) on the rear side is an analog interface. To connect this to a controlling hardware (PC, electronic circuit), a standard plug is necessary (not included in the scope of delivery). It's generally advisable to switch the device completely off before connecting or disconnecting this connector, but at least the DC input.

2.3.11 Connecting the Share bus

The "Share BUS" connectors on the rear side (2x BNC type) can be used to connect to the Share bus of further units of series ELR 10000 4U. The main purpose of the Share bus is to balance the voltage of multiple units in parallel operation, especially when using the integrated function generator of the master unit. For further information about parallel operation refer to section "3.11.1. Parallel operation in master-slave (MS)".

For the connection of the share bus the following must be paid attention to:



Connection is only permitted between compatible devices (see "1.9.10. "Share BUS" connector" for details) and between a max. of 64 units.

2.3.12 Connecting the USB port (rear side)

In order to remotely control the device via this port, connect the device with a PC using the included USB cable and switch the device on.

2.3.12.1 Driver installation (Windows)

On the initial connection with a PC the operating system will identify the device as new hardware and will try to install a driver. The required driver is for a Communications Device Class (CDC) device and is usually integrated in current operating systems such as Windows 7 or 10. But it's strongly recommended to use and install the included driver installer (on USB stick) to gain maximum compatibility of the device to our softwares.

2.3.12.2 Driver installation (Linux, MacOS)

We cannot provide drivers or installation instructions for these operating systems. Whether a suitable driver is available is best carried out by searching the Internet.

2.3.12.3 Alternative drivers

In case the CDC drivers described above are not available on your system, or for some reason do not function correctly, commercial suppliers can help. Search the Internet for suppliers using the keywords "cdc driver windows" or "cdc driver linux" or "cdc driver macos".

2.3.13 Initial commission

For the first start-up after installation of the device, the following procedures have to be executed:

- Confirm that the connection cables to be used are of a satisfactory cross section!
- Check if the factory settings of set values, safety and monitoring functions and communication are suitable for your intended application of the device and adjust them if required, as described in the manual!
- In case of remote control via PC, read the additional documentation for interfaces and software!
- In case of remote control via the analog interface, read the section in this manual concerning analog interfaces!

2.3.14 Commission after a firmware update or a long period of non-use

In case of a firmware update, return of the equipment following repair or a location or configuration change, similar measures should be taken to those of initial start up. Refer to "2.3.13. Initial commission".

Only after successful checking of the device as listed may it be operated as usual.

3. Operation and application

3.1 Important notes

3.1.1 Personal safety



- In order to guarantee safety when using the device, it's essential that only persons operate the device who are fully acquainted and trained in the required safety measures to be taken when working with dangerous electrical voltages
- Read and follow all safety warnings in section 1.7.1!

3.1.2 Genera



- Running the device without any source being connected isn't considered as a normal operation mode and can thus lead to false measurements, for example when calibrating the device
- The optimal working point of the device is between 50% and 100% voltage and current
- It's recommended to not run the device below 10% voltage and current, in order to make sure technical values like accuracy of current and transient times can be met

3.2 Operating modes

A device like this is internally controlled by different control or regulation circuits which shall bring voltage, current and power to the adjusted values and hold them constant, if possible. These circuits follow typical laws of control systems engineering, resulting in different operating modes. Each operating mode has its own characteristics which is explained below in short form.

3.2.1 Voltage regulation / Constant voltage

Voltage regulation is also called constant voltage operation (**CV**).

The voltage on the DC input of the device is held constant on the adjusted value, unless the current or the power according to $P = U_{DC} \cdot I$ reaches the adjusted current or power limit. In both cases the device will automatically change to constant current or constant power operation, whatever occurs first. Then the voltage can't be held constant anymore and will rise to a value resulting from Ohm's law.

While the DC power stage is switched on and constant voltage mode is active, the condition "CV mode active" will be indicated on the graphics display by the abbreviation **CV** and this message will be passed as a signal to the analog interface, as well stored as status which can also be read as a status message via digital interface.

3.2.1.1 Minimum input voltage for maximum current

Due to technical reasons, all models in this series have a minimum internal resistance that requires to provide a specific minimum input voltage (U_{MIN}) in order for the load to be able to draw its rated current (I_{MAX}).

This minimum input voltage varies from model to model and can easily be determined. If less voltage than U_{MIN} is supplied, the load proportionally draws less current, which can be calculated easily.

See principle view to the right.

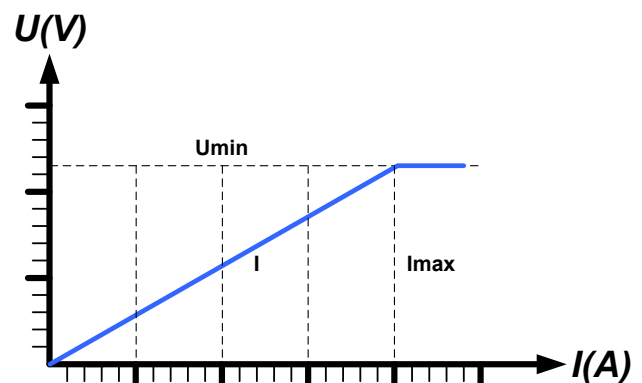

3.2.2 Current regulation / constant current / current limiting

Current regulation is also known as current limiting or constant current mode (**CC**).

The current in the DC input of the device is held constant once the current consumed by the load reaches the adjusted limit. Then the device automatically switches to CC.

As long as the output current is lower than the adjusted current limit, the device will be either in constant voltage or constant power mode. If, however, the power consumption reaches the set maximum power value, the device will switch automatically to power limiting and set voltage and current according to $P = U \cdot I$.

While the DC power stage is switched on and constant current mode is active, the condition "CC mode active" will be indicated on the graphics display by the abbreviation **CC** and this message will be passed as a signal to the analog interface, as well stored as status which can also be read as via digital interface.

3.2.3 Power regulation / constant power / power limiting

Power regulation, also known as power limiting or constant power (**CP**), keeps the DC power constant if the DC input current in relation to the DC input voltage reaches the adjusted limit according to $P = U \cdot I$.

Power limiting operates according to the auto-range principle such that at lower voltages higher current can flow and vice versa, always in order to maintain constant power within the range P_N (see diagram to the right).

While the DC power stage is switched on and constant power mode is active, the condition "CP mode active" will be indicated on the graphics display by the abbreviation **CP**, as well stored as status which can also be read as a status message via digital interface.

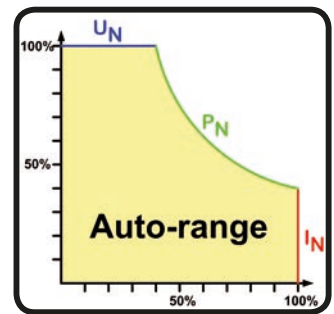

3.2.4 Resistance regulation / constant resistance

Inside electronic loads, whose operating principle is based on a variable internal resistance, constant resistance mode (**CR**) is almost a natural characteristic. The load attempts to set the internal resistance to the user defined value by determining the input current depending on the input voltage according to Ohm's law $I_{IN} = U_{IN} / R_{SET}$. The internal resistance is naturally limited between almost zero and maximum (resolution of current regulation too inaccurate). As the internal resistance cannot have a value of zero, the lower limit is defined to an achievable minimum. This ensures that the electronic load, at very low input voltages, can consume a high input current from the source, up to the maximum.

While the DC input is switched on and constant resistance mode is active, the condition "CR mode active" will be indicated on the graphics display by the abbreviation **CR**, as well it will be stored as internal status which can be read via digital interface.

3.2.5 Dynamic characteristics and stability criteria

The device is an electronic load which is characterized by short rise and fall times of the current, achieved by a high bandwidth of the internal regulation circuit.

In case of testing sources with own regulation circuits at the load, like for example power supplies, a regulation instability may occur. This instability is caused if the complete system (feeding source and electronic load) has too little phase and gain margin at certain frequencies. 180 ° phase shift at > 0dB amplification fulfills the condition for an oscillation and results in instability. The same can occur when using sources without own regulation circuit like batteries and when the connection cables are highly inductive or inductive-capacitive.

The instability isn't caused by a malfunction of the load, but by the behavior of the complete system. An improvement of the phase and gain margin can solve this. In practice, a capacity is directly connected to the DC input, perhaps alternatively to the remote sense input, if connected to the source. The value to achieve the expected result isn't defined and has to be found out. We recommend:

80 V models: 1000uF...4700uF

200/360 V models: 100uF...470uF

500 V models: 47uF...150uF

750/1000 V models: 22uF...100uF

1500 V or higher models: 4.7uF...22uF

3.3 Alarm conditions



This section only gives an overview about device alarms. What to do in case your device indicates an alarm condition is described in section "3.6. Alarms and monitoring".

As a basic principle, all alarm conditions are signaled optically (text + message in the display) and acoustically (if activated), as well as status via digital interface. In addition, the alarms are reported as signals on the analog interface. For later acquisition, an alarm counter can also be shown on display or read via digital interface.

3.3.1 Power Fail

Power Fail (PF) indicates an alarm condition which may have various causes:

- AC input voltage too low (mains undervoltage, mains failure)
- Defect in the input circuit (PFC)
- One or multiple power stages in the device are faulty

As soon as a power fail occurs, the device will stop to sink power, stop to feed back to AC and switch off the DC input. In case the power fail was an undervoltage and is gone later on, the device can continue to work as before, but this depends on a parameter in the settings menu called "DC input -> State after PF alarm". The default setting would keep the DC input switched off, but leave the alarm in the display for notification.



Powering the device down (power switch) can't be distinguished from a supply blackout and thus the device will signal a PF alarm every time it's switched off. This can be ignored.

3.3.2 Overtemperature

An overtemperature alarm (OT) can occur from an excess temperature inside the device and temporarily causes it to switch of the power stage(s). This is usually due to the ambient temperature exceeding the specified operating temperature range of the device. After cooling down, the device can automatically switch the DC input back on, depending on the setting of parameter "DC input -> State after OT alarm". Also see section 3.4.3.1 for more information. The alarm will remain in the display as notification and can be cleared anytime.

3.3.3 Overvoltage protection

An overvoltage alarm (OVP) will switch off the DC input and can occur if...

- the connected voltage source provides a higher voltage to the DC input than set in the overvoltage alarm thresholds (OVP, 0... 110% U_{NOM})

This function serves to warn the user acoustically or optically that the device probably has experienced an excessive voltage which could damage it.



The device isn't fitted with protection from external overvoltage and could even be damaged when not powered

3.3.4 Overcurrent protection

An overcurrent alarm (OCP) will switch off the DC input and can occur if...

- the current in the DC input reaches the adjusted OCP limit.

This function serves to protect the connected external source so it's not overloaded and possibly damaged due to an excessive current, which can also occur due to a defect.

3.3.5 Overpower protection

An overpower alarm (OPP) will switch off the DC power stages and can occur if...

- the product of the voltage and current on the DC input reaches the adjusted OPP limit.

This function serves to protect the connected external source so it's not overloaded and possibly damaged due to an excessive power.

3.3.6 Share bus fail

A Share bus fail alarm (short: SF) will switch off the DC input and can occur if:

- the Share bus connectors of at least two units are already wired while at least one unit isn't yet configured for master-slave
- a short-circuit on the Share bus has occurred, for example due to a damaged BNC cable.

This function serves to prevent sending irregular control signals to the slave units via the Share bus or to cause them to react differently. This alarm has to be acknowledged after the cause has been removed.

3.4 Manual operation

3.4.1 Switching on the device

The device should, as far as possible, always be switched on using the rotary switch on the front of the device. Alternatively this can take place using an external cutout (contactor, circuit breaker) of suitable current capacity.

After switching on, the display will first show some device related information (model, firmware versions etc.) and then a language selection screen for 3 seconds. A few seconds later it will show the main screen.

In the **“Settings”** menu (also see section **“3.4.3. Configuration via the menu”**) in the group **“DC input”** is an option **“State after power ON”** in which the user can determine the condition of the DC power stages after power-up. Factory setting here is **“Off”**, meaning that the DC power stage on power-up are always switched off. **“Restore”** means that the last condition will be restored, either on or off. All set values are always saved and restored.



For the time of the start phase the analog interface can signal undefined statuses on its digital outputs. This must be ignored until the device has finished booting and is ready to work.

3.4.2 Switching the device off

On switch-off the last condition of the power stage and the most recent set values are saved. Furthermore, a PF alarm (power failure) will be reported, but can be ignored.

The DC power stage is immediately switched off and after a short while fans will shut down and after another few seconds the device will be completely powered off.

3.4.3 Configuration via the menu

The settings menu is meant for the configuration of all operating parameters which are not constantly required. The menu is accessed by finger touch on the **Menu** touch area, but only while the DC input is switched off. See figure to the right.

While the DC input is switched on the settings menu will not be shown, but some status information.

Menu navigation is also done by finger touch. Inside menus, all values are adjusted using the numeric pad that pops up when tapping a value.

Many settings are self-explanatory, others are not. Those will be explained on the pages following.

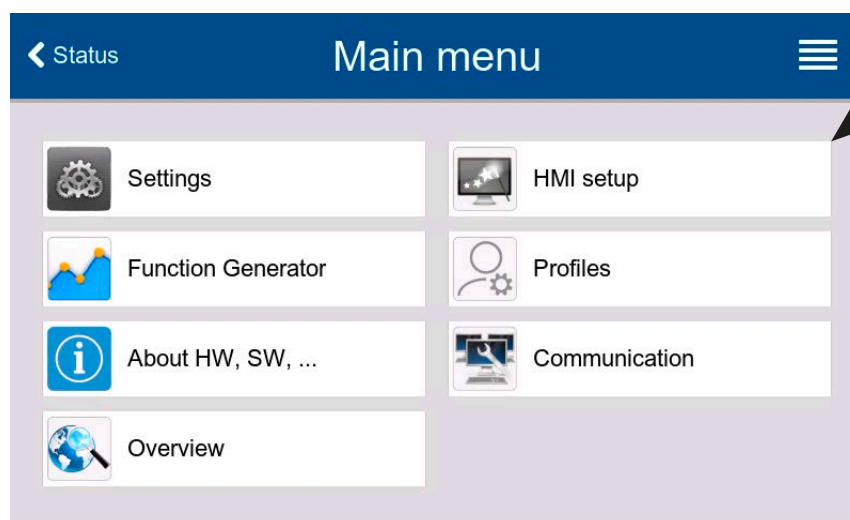
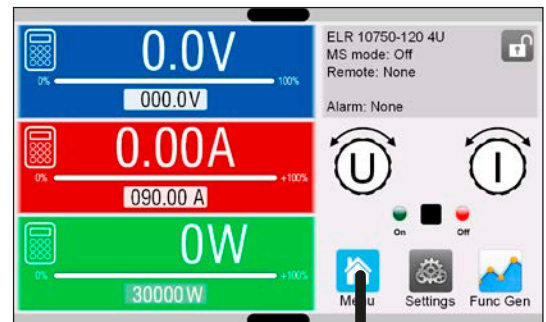

3.4.3.1 Sub menu “Settings”

This sub menu can be accessed directly from the main screen by tapping the Settings button.

Group	Parameters & description
Presets	U, I, P, R
	Presetting of all set values via on-screen numeric pad.
Protection	OVP, OCP, OPP
	Adjust the thresholds of the protections
Limits	U-max, U-min etc.
	Define the adjustment limits (find more information in “3.4.4. Adjustment limits”)
User events	UVD, OVD etc.
	Define supervision thresholds which can trigger user defined events (find more information in “3.6.2.1. User defined events”)
General	Allow remote control
	If remote control is allowed, the device cannot be controlled remotely over either the digital or analog interfaces. This situation will be shown as “ Local ” in the status area on the main display. Also see section 1.9.6.1.
	R mode
	Activates or deactivates the internal resistance control. If activated, the resistance set value and actual will be shown the main screen. For details refer to “3.2.4. Resistance regulation / constant resistance” and “3.4.6. Manual adjustment of set values”.
Analog interface	Range
	Selects the voltage range for the analog set values, actual values and reference voltage output. <ul style="list-style-type: none"> • 0...5 V = Range is 0...100% for set /actual values, reference voltage will be 5 V • 0...10 V = Range is 0...100% for set /actual values, reference voltage will be 10 V Also see “3.5.4. Remote control via the analog interface”
	REM-SB Level
	Selects how the input pin REM-SB of the analog interface shall be working regarding levels (see “3.5.4.3. Analog interface specification”) and logic: <ul style="list-style-type: none"> • Normal = Levels and function as described in the table in 3.5.4.3 • Inverted = Levels and function will be inverted Also see “3.5.4.7. Application examples”
	REM-SB Action
	Selects how the input pin REM-SB of the analog interface shall operate regarding the DC input condition outside of analog remote control: <ul style="list-style-type: none"> • DC Off = the pin can only switch the DC power stage off • DC On/Off = the pin can switch the DC power stage off and on again, if it has been switched on before from a different control location
	Pin 6
Pin 6 of the analog interface (see section 3.5.4.3) is by default assigned to signal both device alarms OT and PF. This parameter allows to also enable signaling only one of both (3 possible combinations): <ul style="list-style-type: none"> • Alarm OT = Signals only alarm OT • Alarm PF = Signals only alarm PF • Alarm PF + OT = Default, signals either PF or OT 	

Group	Parameters & description
Analog interface	Pin 14 Pin 14 of the analog interface (see section 3.5.4.3) is by default assigned to only signal the device alarm OVP. This parameter allows to also enable signaling the device alarms OCP and OPP in 7 possible combinations: <ul style="list-style-type: none"> • Alarm OVP = Signals only OVP on pin 14 • Alarm OCP = Signals only OCP on pin 14 • Alarm OPP = Signals only OPP on pin 14 • Alarm OVP+OCP = Signals OVP or OCP on pin 14 • Alarm OVP+OPP = Signals OVP or OPP on pin 14 • Alarm OCP+OPP = Signals OCP or OPP on pin 14 • Alarm OVP+OCP+OPP = Signals all three on pin 14
	Pin 15 Pin 15 of the analog interface (see section 3.5.4.3) is by default assigned to only signal the regulation mode CV. This parameter allows to enable signaling the DC input status (2 options): <ul style="list-style-type: none"> • Regulation mode = Signals only CV reg mode on pin 15 • DC status = Signals only the DC input status on pin 15
DC input	State after power ON Determines the condition of the DC input after power-up. <ul style="list-style-type: none"> • Off = DC input is always off after switching on the device. • Restore = Default, DC input state will be restored from last switch-off.
	State after PF alarm Determines the condition of the DC input after a power fail (PF) alarm: <ul style="list-style-type: none"> • Off = Default, DC input remains off • Auto = DC input will switch on again after the PF alarm cause is gone, if it has been switched on before the alarm occurred
	State after remote Determines the condition of the DC input after leaving remote control either manually or by command: <ul style="list-style-type: none"> • Off = Default, DC input will always be off after leaving remote control • Auto = DC input will keep the last state
	State after OT alarm Determines the condition of the DC input after an overtemperature (OT) alarm, once the device has cooled down: <ul style="list-style-type: none"> • Off = DC input will remain off • Auto = Default, the device will automatically restore the situation before the OT alarm, which usually means the DC input to be on

Group	Parameters & description
Master-slave	Mode
	Selecting “ Master ” or “ Slave ” enables the master-slave mode (MS) and defines the position for the unit in the MS system. For details see section “3.11.1. Parallel operation in master-slave (MS)”.
	Termination resistor
	Activates or deactivates the so-called bus termination of the digital master-slave bus via a switchable resistor. Termination should be activation if required, usually when problems with the master-slave bus operation occur.
	Bias resistors
	Additionally to the regular termination resistor there are two bias resistor to be activated if required to help stabilize the bus further. Tap on the information symbol for a graphical depiction.
	Backlight off after 60s
	If activated, it will switch off the display’s backlight after 60 seconds of inactivity. This settings is primarily intended for slave units where the display isn’t supposed to be permanently on. It’s identical to the setting in menu “HMI setup”.
USB logging	Initialize system
	Tapping this touch area will repeat the initialization of the master-slave system in case the detection of all slave units by the master was unsuccessful, so the system would have less total power than expected, or has to be repeated manually in case the master unit couldn’t detect a missing slave or one slave has failed.
	Log file separator format
	Defines the format of CSV files generated from logging files (also see 1.9.6.5 and 3.4.8). This setting also affects other features where a CSV file can be loaded or saved. <ul style="list-style-type: none"> • US = Comma as column separator (US standard for CSV files) • Default = Semicolon as column separator (german/european standard for CSV files)
	Logging with units (V,A,W)
	CSV files generated from USB logging by default add physical units to values. This can be deactivated here.
	USB logging
	Activates/deactivates logging to USB stick. For more information refer to “3.4.8. Recording to USB stick (logging)”.
Reset / Restart	Logging interval
	Defines the time between two records in the log file. Selection: 500 ms, 1 s, 2 s, 5 s
	Start/stop
	Defines how the USB logging is started and stopped. <p>Manual = Logging only starts and stops upon user interaction on the HMI, by accessing touch button  in the quick menu.</p> <p>At DC on/off = Logging starts and stops with every change of state on the DC input, no matter if caused by the user, software or a device alarm. Attention: Every next start will create a new log file.</p>
	Reset device to defaults
This touch area will initiate a reset of all settings (HMI, profile etc.) to factory default.	
Restart	
Triggers a warm start	

3.4.3.2 Sub menu “Profiles”

See “3.9 Loading and saving user profiles” on page 68.

3.4.3.3 Sub menu “Overview”

This menu page displays an overview of the set values (U, I, P or U, I, P, R), device alarm thresholds, event settings, adjustment limits, as well as an alarm history which lists the number of device alarms that occurred since the device has been powered.

3.4.3.4 Sub menu “About HW, SW, ...”

This menu page displays an overview of device relevant data such as serial number, article number etc.

3.4.3.5 Sub menu “Function Generator”

See “3.10. The function generator”.

3.4.3.6 Sub menu “Communication”

This sub menu offers settings for digital communication via the built-in interfaces USB and Ethernet and also for the optional interface modules of IF-AB series.

There is furthermore an adjustable communication timeout for USB or RS232, to make it possible to successfully transfer fragmented messages (data packets) using higher values. In group “**Protocols**” you can disable one of the two supported communication protocols, ModBus and SCPI. This can help to avoid mixing both protocols and to receive unreadable messages, for example when expecting a SCPI response and getting a ModBus response instead.

The USB itself doesn’t require any settings. The device will have following default Ethernet port related settings which are listed in group “**Ethernet (internal)**”:

IF	Settings	Description
Ethernet (internal)	DHCP	The IF allows a DHCP server to allocate an IP address, a subnet mask and a gateway. If no DHCP server is in the network then network parameters will be set as defined below.
	IP address	Manually allocate an IP address.
	Subnet mask	Manually allocate a subnet mask.
	Gateway	Manually allocate a gateway address, if required.
	DNS address	Manually allocate addresses of a Domain Name Server (DNS), if required.
	Port	Select port in the range 0...65535. Default: 5025 Reserved: 502 (Modbus TCP), 537
	Host name	User definable host name
	Domain	User definable domain

Settings for the optional interface modules (IF-AB-xxx)

IF	Settings	Description
CANopen	Baud Rate	CAN bus baud rate selection that is used by the CANopen interface. Auto = Automatic detection LSS = Baud rate and node address are assigned by the bus master Fixed baud rates: 10 kbps, 20 kbps, 50 kbps, 100 kbps, 125 kbps, 250 kbps, 500 kbps, 800 kbps, 1Mbps
	Node Address	Selection of the CANopen node address in the range 1...127

IF	Settings	Description
Profibus	Node Address	Selection of the Profibus or node address of the device within range 1...125 via direct input
	Function Tag	String input box for a user-definable text which describes the Profibus slave function tag. Max. length: 32 characters
	Location Tag	String input box for a user-definable text which describes the Profibus slave location tag. Max. length: 22 characters
	Installation Date	String input box for a user-definable text which describes the Profibus slave installation date tag. Max. length: 40 characters
	Description	String input box for a user-definable text which describes the Profibus slave. Max. length: 54 characters
	Manufacturer ID	Registered manufacturer ID with the Profibus organization
	Ident number	Product identification number, same as in the GSD file

IF	Settings	Description
Slot Ethernet, ModBus-TCP (1 & 2 Port)	DHCP	The IF allows a DHCP server to allocate an IP address, a subnet mask and a gateway. If no DHCP server is in the network then network parameters will be set as defined below.
	IP address	This option is activated by default. An IP address can be manually allocated.
	Subnet mask	Here a subnet mask can be defined if the default subnet mask isn't suitable.
	Gateway	Here a gateway address can be allocated if required..
	DNS address	Here the addresses of the first and second Domain Name Servers (DNS) can be defined, if needed.
	Port	Range: 0...65535. Default port: Default port: 5025 = Modbus RTU Reserved ports: 502 (Modbus TCP), 537
	Host name	User definable host name (default: Client)
	Domain	User definable domain (default: Workgroup)
	Speed / Duplex Port 1	Manual selection of transmission speed (10MBit/100MBit) and duplex mode (full/half). It's recommended to use the " Auto " option and only revert to another option if Auto fails.
	Speed / Duplex Port 2	Different Ethernet port settings for 2-port modules are possible, as these include an Ethernet switch

IF	Settings	Description
Profinet/IO (1 & 2 Port)	Host name	Free choice of host name (default: Client)
	Domain name	Free choice of Domain (default: Workgroup)
	Function Tag	String input box for a user-definable text which describes the Profinet slave function tag. Max. length: 32 characters
	Location Tag	String input box for a user-definable text which describes the Profinet slave location tag. Max. length: 22 characters
	Installation Date	String input box for a user-definable text which describes the Profibus slave installation date tag. Max. length: 40 characters
	Description	String input box for a user-definable text which describes the Profibus slave. Max. length: 54 characters
	Station Name	String input box for a user-definable text which describes the Profinet station name. Max. length: 200 characters

IF	Settings	Description
CAN	Baud rate	Setup of the CAN bus speed or baud rate in typical value between 10 kbps and 1Mbps. Default: 500 kbps
	ID Format	Selection of the CAN ID format and range between Standard (11 Bit ID, 0h...7ffh) and Extended (29 Bit, 0h...1fffffffh)
	Termination	Activates or deactivates CAN bus termination with a built-in resistor. Default: off
	Data length	Determines the DLC (data length) of all messages sent from the device. Auto = length can vary between 3 and 8 bytes Always 8 Bytes = length is always 8, filled up with zeros
	Base ID	Setup of the CAN base ID (11 Bit or 29 Bit, hex format). Default: 0h
	Broadcast ID	Setup of the CAN broadcast ID (11 Bit or 29 Bit, hex format). Default: 7ffh
	Base ID Cyclic Read	Setup of the CAN base ID (11 Bit or 29 Bit, hex format) for cyclic read of several object groups. The device will automatically send object data to the IDs defined with this setting. For more information refer to the programming guide. Default: 100h
	Base ID Cyclic Send	Setup of the CAN base ID (11 Bit or 29 Bit, hex format) for cyclic send of set values along with status. For more information refer to the programming guide. Default: 200h
	Cyclic Read Time Status	Activation/deactivation and time setting for the cyclic read of status from the adjusted „ Base ID Cyclic Read “ Range: 20...5000 ms. Default: 0 ms (deactivated)
	Cyclic Read Time Actual	Activation/deactivation and time setting for the cyclic read of actual values from the adjusted „ Base ID Cyclic Read + 1 “ Range: 20...5000 ms. Default: 0 ms (deactivated)
	Cyclic Read Time Set	Activation/deactivation and time setting for the cyclic read of set values of U & I from the adjusted „ Base ID Cyclic Read + 2 “. Range: 20...5000 ms. Default: 0 ms (deactivated)
	Cyclic Read Time Limits 1	Activation/deactivation and time setting for the cyclic read of adjustment limits of U & I from the adjusted „ Base ID Cyclic Read + 3 “. Range: 20...5000 ms. Default: 0 ms (deactivated)
	Cyclic Read Time Limits 2	Activation/deactivation and time setting for the cyclic read of adjustment limits of P & R to the adjusted „ Base ID Cyclic Read + 4 “. Range: 20...5000 ms. Default: 0 ms (=deactivated)
	Module firmware	CAN module firmware version

IF	Settings	Description
RS232	Baud rate	The baud rate is selectable, other serial settings can't be changed and are defined like this: 8 data bits, 1 stop bit, parity = none Baud rates: 2400Bd, 4800Bd, 9600Bd, 19200Bd, 38400Bd, 57600Bd, 115200Bd

Group	Parameters & description
Timeouts	TCP keep-alive
	Activates keep-alive network functionality for the Ethernet port, which is used to keep the socket connection open. As long as keep-alive is valid in the network, the device will disable the Ethernet timeout. Also see below at "Timeout ETH".
	Timeout USB/RS232
	Defines the max. time between two subsequent bytes or blocks of a transferred message. For more information about the timeout refer to the external programming documentation "Programming ModBus & SCPI". Default value: 5 ms , Range: 5...65535
	Timeout ETH
	Defines a timeout after which the device would close the socket connection if there was no command communication between the controlling unit (PC, PLC etc.) and the device for the adjusted time. The timeout is ineffective as long as option "TCP keep-alive" is enabled and the keep-alive network service is running. Default value: 5 s , Range: 5...65535
Protocols	Communication protocols
	Enables or disables SCPI or ModBus communication protocols for the device. The change is immediately effective. Only one of both can be disabled.
	ModBus specification compliance
	Allows to switch from " Limited " (default setting) to " Full " which makes the device send messages in ModBus RTU or ModBus TCP format which fully comply to the specification and are compatible to softwares available on the market. With " Limited " the device would still use the old, partially wrong message format (see programming guide for details).

3.4.3.7 Menu "HMI Setup"

These settings refer exclusively to the control panel (HMI).

Group	Parameters & description
Language	Selection of the display language between German, English (default), Russian or Chinese
Sound	Key sound
	Activates or deactivates sounds when touching a touch area in the display. It can usefully signal that the action has been accepted.
	Alarm sound
	Activates or deactivates the additional acoustic signal of an alarm or user defined event which has been set to "Action = Alarm". See also "3.6. Alarms and monitoring".
Clock	Internal clock and date setup
Backlight	Backlight off after 60s
	The choice here is whether the backlight remains permanently on (default) or if it should go off when no input via screen or rotary knob is done for 60 s. As soon as there is input, the backlight returns automatically. Furthermore, the backlight intensity can be adjusted here.
Lock	See ""3.7. Locking the control panel (HMI)" and "3.8. Locking the "Limits" and "Profiles""

3.4.4 Adjustment limits



Adjustment limits are only effective on the related set values, no matter if using manual adjustment or remote control setting!



Defaults are that all set values (U, I, P, R) are adjustable from 0 to 102%.

The full range may be obstructive in some cases, especially for protection of applications against overvoltage. Therefore upper and lower limits for current (I) and voltage (U) can be set separately, which then limit the range of the adjustable set values.

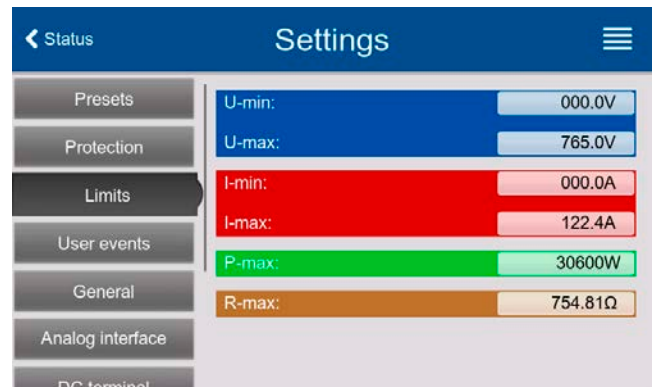
For power (P) and resistance (R) only upper value limits can be set.



► How to configure the adjustment limits

1. While the DC input is switched off, tap  on the main screen.
2. Tap on group “Limits” on the left side to open the list of limits. They are grouped and colored for distinction. Values are adjusted by tapping on them, in a window popping up with a numeric pad.
3. Adjust the desired value and submit with .



The adjustment limits are coupled to the set values. It means, that the upper limit may not be set lower than the corresponding set value. Example: If you wish to set the limit for the power set value (P-max) to 6000 W while the currently adjusted power set value is 8000 W, then the set value first would have to be reduced to 6000 W or less, in order to set P-max down to 6000 W.

3.4.5 Changing the operating mode

In general, the manual operation of the device distinguishes between three operating modes: U/I, U/P and U/R. They are tied to set value input using the rotary knobs or the on-screen numeric pad. The current assignment can be switched anytime if you want to adjust a set value which is currently not assigned to any of the knobs.

► How to change the operating mode (two options)

1. Unless the device is in remote control or the panel is locked, tap on the depiction of the right-hand knob on the screen (see figure to the right) to change its assignment between I, P and R (if resistance mode is activated). The knob will display accordingly, with letters.
2. Directly tap on the colored areas with the set values, like shown in the figure to the right. The set value field, when inverted, indicates the assignment to the knob. In the example in the figure it has U and I assigned, which means U/I mode.

Depending on the selection the right rotary knob will be assigned different setting values, the left knob is always assigned to the voltage.



In order to change the other values, like P or R while U/I is active, and without switching the assignment all the time, direct input can be used. See section 3.4.6.

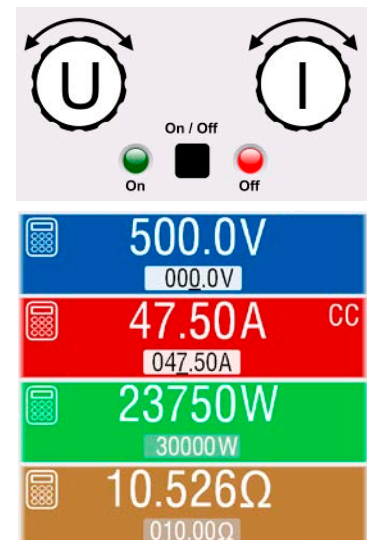

The actual operating mode, which is only indicated while the DC input is switched on, solely depends only on the set values. For more information see section “3.2. Operating modes”.

3.4.6 Manual adjustment of set values

Adjusting set values for current, power and resistance are the fundamental operating possibilities of an electronic load and hence in manual operation the two rotary knobs on the front of the device are always assigned to two of the values.

The resistance value is connected to the "R mode" which has to be activated separately, for instance via the quick menu. Refer to "3.4.3. Configuration via the menu" as well as "3.2.4. Resistance regulation / constant resistance" for details.

Set values can be entered manually in two ways, via **rotary knob** or **direct input**. While the rotary knobs adjust values continuously, entering them via numeric pad can be used to change values in steps, no matter how big.



Changing a value is immediately submitted, no matter if the DC input is switched on or off.



When adjusting set values, upper and lower limits may come into effect. See section "3.4.4. Adjustment limits". Once a limit is reached, the display will show a small note like "Limit: U-max" etc. for a short time in proximity to the adjusted value.



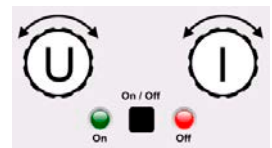

► How to adjust set values U, I, P or R with the rotary knobs

1. First check if the value you want to change is already assigned to one of the rotary knobs. The main screen displays the assignment as depicted in the figure to the right.
2. If, as shown in the example, the assignment is voltage (U, left knob) and current (I, right knob), and it's required to set the power, then the assignment of the right-hand knob can be changed by tapping on its depiction until it shows "P". In the left-hand display area the set values of power would then be shown as selected.
3. After successful selection, the desired value can be set within the defined limits. Selecting the next digit is done by pushing the rotary knob which shifts the cursor from right to left (selected digit will be underlined):



47.50A → 47.50A → 47.50A

► How to adjust values via direct input:

1. In the main screen, depending on the rotary knob assignment, values can be set for voltage (U), current (I), power (P) or resistance (R) via direct input by tapping on one of the small ten-key pad symbols, for example the one in the blue area if you wanted to adjust the voltage.
2. Enter the required value using the ten-key pad. Similar to a pocket calculator the key  clears the input. Decimal values are set by tapping the point key. For example, 54.3 V is entered with    and .
3. Unless the new values isn't rejected for some reason, the display would then switch back to the main page and the set value would be submitted to the DC input.

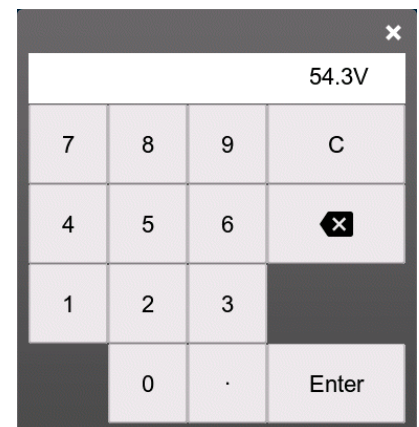

Upon entering a value which exceeds the corresponding limit, a note would pop up, the value in the frame reset to 0 and not be accepted and submitted.

3.4.7 Switching the DC input on or off

The DC input of the device can be manually or remotely switched on and off.



Switching the DC input on during manual operation or digital remote control can be disabled by pin REM-SB of the built-in analog interface. For more information refer to 3.4.3.1 and example a) in 3.5.4.7.

► How to manually switch the DC input on or off

1. As long as the control panel isn't completely locked press the button **On/Off**. Otherwise you are asked to disable the HMI lock. In case the HMI lock is connected to a PIN, you are asked to enter the PIN first.
2. With the possible HMI lock removed, button **On/Off** toggles the DC input state, as long as this isn't restricted by an alarm or the device being in remote control.

► How to remotely switch the DC input on or off via the analog interface

1. See section "3.5.4. Remote control via the analog interface".

► How to remotely switch the DC input on or off via the digital interface

1. See the external documentation "Programming Guide ModBus & SCPI" if you are using custom software, or refer to the external documentation from LabVIEW VIs or other software provided by the manufacturer.

3.4.8 Recording to USB stick (logging)

Device data can be recorded to USB stick (USB 3.0 is supported, but not all memory sizes) anytime. For specifications of the USB stick and the generated log files refer to section "1.9.6.5. USB port (front side)".

The logging stores files of CSV format on the stick where the layout of the log data is the same as when logging via PC with software EPS Power Control. The advantage of USB logging over PC logging is the mobility and that no PC is required. The logging feature just has to be activated and configured in the Settings.

3.4.8.1 Configuration



Also see section 3.4.3.6. After USB logging has been enabled and the parameters "**Logging interval**" and "**Start/Stop**" have been set, logging can be started anytime from within the Settings menu or when switching the DC input on, all depending on the selected start/stop mode.



Furthermore see section 3.4.3.1. There are additional settings for the CSV file itself as generated by the USB logging features. You can switch the column separator format between german/european standard ("**Default**") or US american standard ("**US**"). The other option is used to deactivate the physical unit that is added by default to every set/actual value in the log file. Deactivating this option simplifies the CSV file processing in MS Excel or similar tools.

3.4.8.2 Handling (start/stop)

With setting "**Start/stop**" to **At DC on/off** logging will start each time the DC input of the device is switched on, no matter if manually with the front button **On/Off** or remotely via analog or digital interface. With setting **Manual** it's different. Logging is then started and stopped only in the quick menu (see figure to the right).



Button  starts logging manually and changed to , which is for manual stop.

Soon after logging has been started, the symbol  indicates the ongoing logging action. In case there is an error while logging, such as the USB stick is full or removed, it will be indicated by another symbol (). After every manual stop or switching the DC input off the logging is stopped and the log file closed.

3.4.8.3 USB logging file format

Type: text file in german/european or US american CSV format (depending on the selected setting)

Layout:

	A	B	C	D	E	F	G	H	I	J	K	L	M
1	U set	U actual	I set	I actual	P set	P actual	R set	R actual	R mode	Output/Input	Device mode	Error	Time
2	2,00V	11,92V	1,20A	1,20A	7344W	15W	N/A	N/A	OFF	ON	CC	NONE	00:00:00,942
3	2,00V	11,90V	1,20A	1,20A	7344W	15W	N/A	N/A	OFF	ON	CC	NONE	00:00:01,942
4	2,00V	11,89V	1,20A	1,20A	7344W	15W	N/A	N/A	OFF	ON	CC	NONE	00:00:02,942
5	2,00V	11,87V	1,20A	1,20A	7344W	15W	N/A	N/A	OFF	ON	CC	NONE	00:00:03,942

Legend:

U set / I set / P set / R set: Set values U, I, P and R

U actual / I actual / P actual / R actual: Actual values

Output/Input: State of the DC input

Device mode: Actual regulation mode (also see “3.2. Operating modes”)

Error: Device alarms

Time: Elapsed time since logging start

Important to know:

- R set and R actual are only recorded if “R mode” is active (refer to section 3.4.5)
- Unlike the logging on PC, every log start here creates a new log file with a counter in the file name, starting generally with 1, but minding existing files

3.4.8.4 Special notes and limitations

- Max. log file size (due to FAT32 formatting): 4 GB
- Max. number of log files in folder HMI_FILES: 1024
- With setting **Start/stop** being **At DC on/off**, the logging will also stop on alarms or events with action “Alarm”, because they switch off the DC input
- With setting **Start/stop** being **Manual**, the device will continue to log even on occurring alarms, so this mode can be used to determine the period of temporary alarms like OT or PF

3.4.9 The quick menu



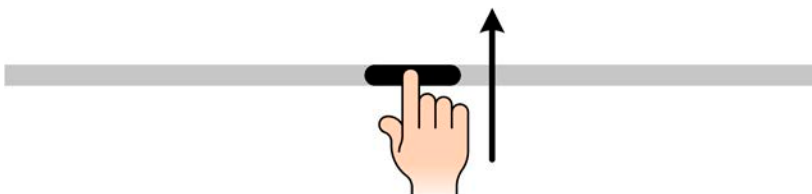







The device offers a quick menu which allows for the quick access to often used features and modes being switched on or off in the “Settings” menu. It can be opened by swiping up from the bottom screen edge or tapping the bar:



Overview:



Tapping a button activates and then deactivates the function again. Buttons with black on white indicate an activated feature:

Symbol	Belongs to	Meaning
	USB logging	USB logging is running (the symbols is only available when USB logging has been activated in menu "Settings")
	Master-slave	Master-slave activated, device is master
	Master-slave	Master-slave activated, device is slave
	Master-slave	Master-slave deactivated
	Resistance mode	R mode = on
	HMI	Alarm sound = on
	HMI	Key sound = on
	HMI	Opens the graph screen
	HMI	Adjust backlight intensity
	HMI	Opens the main menu

3.4.10 The graph

The devices feature a manually callable, HMI operated visual depiction of the temporal run of the actual values of voltage, current and power, called graph. It isn't a recording feature whatsoever. For data recording in the background there is still the USB logging feature (see 3.4.8).

In normal operation the graph can be called anytime via the quick menu, while in function generator operation it's called by an extra screen button. Once called, it completely fills the screen.



Limited control options available while the graph is up! However, for safety reasons it's possible to switch off the DC output anytime.

Overview:

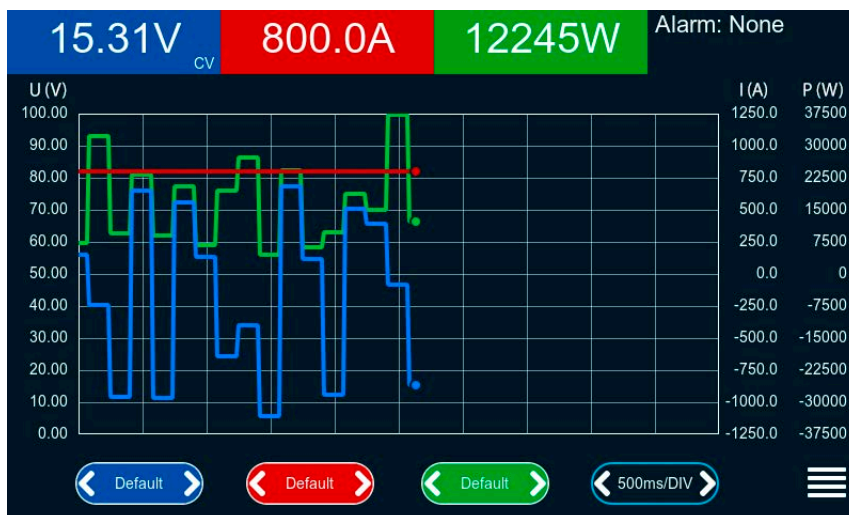

Controls:

- Tapping the **middle** of the three colored touch area deactivates/activate the corresponding plot
- Tapping the **sides** (arrows left/right) of the three colored touch areas increases/decreases the vertical scaling
- Tapping the **sides** (arrows left/right) of the black touch area increases/decreases the horizontal scaling
- Swiping on the three scales moves them up or down
- Tapping the menu touch area () exits the graph screen anytime

3.5 Remote control

3.5.1 General

Remote control is possible via one of the built-in interfaces (analog, USB, Ethernet) or via one of the optional interface modules. Important here is that only the analog or one digital interface can be in control. One of the digital ones is the master-slave bus.

It means that if an attempt was made to switch to remote control via the digital interface whilst analog remote control is active (pin REMOTE = LOW) the device would report an error via the digital interface. In the opposite direction, a switch-over via pin REMOTE would be ignored. However, status monitoring and reading of values are always possible.

3.5.2 Control locations

Control locations are those locations from where the device can be controlled. Essentially there are two: at the device (manual operation) and external (remote control). The following locations are defined:

Displayed location	Description
Remote: None	If neither of the other locations is displayed then manual control is active and access from the analog and digital interfaces is allowed.
Remote: <interface_name>	Remote control via any interface is active
Local	Remote control is locked, only manual operation is allowed.

Remote control may be allowed or inhibited using the setting “**Allow remote control**” (see “3.4.3.1. Sub menu “Settings”). In inhibited condition the status “**Local**” will be displayed top right. Activating the inhibit can be useful if the device is remotely controlled by software or some electronic device, but it’s required to make adjustments at the device or deal with emergency.

Activating condition “**Local**” causes the following:

- If remote control via the digital interface is active (e. g. “**Remote: USB**”), then it’s immediately terminated and in order to continue remote control once “**Local**” is no longer active, it has to be reactivated at the PC
- If remote control via the analog interface is active (“**Remote: Analog**”), then it’s temporarily interrupted until remote control is allowed again by deactivating “**Local**”, because pin REMOTE continues to signal “remote control = on”, unless this has been changed during the “**Local**” period.

3.5.3 Remote control via a digital interface

3.5.3.1 Selecting an interface

All models of series ELR 10000 support, in addition to the built-in USB and Ethernet ports, the following optionally available interface modules:

Short ID	Type	Ports	Description*
IF-AB-CANO	CANopen	1	CANopen slave with generic EDS
IF-AB-RS232	RS232	1	Standard RS232, serial
IF-AB-PBUS	Profibus	1	Profibus DP-V1 slave
IF-AB-PNET1P	ProfiNet	1	Profinet DP-V1 slave
IF-AB-PNET2P	ProfiNet	2	Profinet DP-V1 slave, with switch
IF-AB-CAN	CAN	1	CAN 2.0 A / 2.0 B
IF-AB-ECT	EtherCAT	2	Standard EtherCAT slave with CoE
IF-AB-MBUS	ModBus TCP	1	ModBus TCP protocol via Ethernet
IF-AB-MBUS2P	ModBus TCP	2	ModBus TCP protocol via Ethernet

* For technical details of the various modules see the extra documentation “Programming Guide Modbus & SCPI”

3.5.3.2 Programming

Programming details for the interfaces, the communication protocols etc. are to be found in the documentation “Programming Guide ModBus & SCPI” which is supplied on the included USB stick or which is available as download from the manufacturer’s website.

3.5.4 Remote control via the analog interface

3.5.4.1 General

The built-in, galvanically isolated, 15-pole analog interface, below referenced in short form as AI, is located on the rear side of the device offers the following possibilities:

- Remote control of current, voltage, power and resistance
- Remote status monitoring (CV, DC input)
- Remote alarm monitoring (OT, OVP, PF, OCP, OPP)
- Remote monitoring of actual values
- Remote on/off switching of the DC input

Setting the **three** set values of voltage, current and power via the analog interface must always be done concurrently. It means, for example, that the voltage can't be given via the AI and current and power set by the rotary knobs or vice versa. The internal resistance set value can additionally be adjusted.

Analog set values can be supplied by an external voltage or generated from the reference voltage on pin 3. As soon as remote control via the analog interface is activated, the displayed set values will be those provided by the interface. The AI can be operated in the common voltage ranges 0...5 V and 0...10 V, both representing 0...100% of the nominal value. The selection of the voltage range can be done in the device setup. See section "3.4.3. Configuration via the menu" for details. The reference voltage sent out from pin 3 (VREF) will be adapted accordingly:

0-5 V: Reference voltage = 5 V, 0...5 V set value (VSEL, CSEL, PSEL, RSEL) correspond to 0...100% rated value resp. $R_{Min}...R_{Max}$, 0...100% of the actual values correspond to 0...5 V at the outputs CMON and VMON, at least as long these two pins are still configured for the default (see section "3.4.3. Configuration via the menu").

0-10 V: Reference voltage = 10 V, 0...10 V set value (VSEL, CSEL, PSEL, RSEL) correspond to 0...100% rated value resp. $R_{Min}...R_{Max}$, 0...100% of the actual values correspond to 0...10 V at the outputs CMON and VMON, at least as long these two pins are still configured for the default (see section "3.4.3. Configuration via the menu").

Input of excess signals (e.g. >5 V in selected 5 V range or >10 V in the 10 V range) are clipped by the device by setting the corresponding set value to 100%.

The OVP set value and other supervision (events) and alarm thresholds cannot be set via the AI and therefore must be adapted to the given situation before the AI is going to be in control.

Before you begin, please read these important notes about the use of the interface:



After powering the device and during the start phase the AI signals undefined statuses on the output pins. Those must be ignored until is ready to work.

- Analog remote control of the device must be activated by switching pin REMOTE (5) first. Only exception is pin REM-SB, which can be used independently
- Before the hardware is connected that will control the analog interface, it shall be checked that it can't provide voltage to the pins higher than specified
- Set value inputs, such as VSEL, CSEL, PSEL and RSEL (if R mode is activated), must not be left unconnected (i.e. floating) during analog remote control. In case any of the set values isn't used for adjustment, it can be tied to a defined level or connected to pin VREF (solder bridge or different), so it gives 100%

3.5.4.2 Acknowledging device alarms

In case of a device alarm occurring during remote control via analog interface, the DC input will be switched off the same way as in manual control. The device would indicate an alarm (see 3.6.2) in the front display and, if activated, acoustically and also signal most of them on the analog interface. Which alarms actually are signaled can be set up in the device configuration menu (see "3.4.3.1. Sub menu "Settings"").

The alarms MSP, OVP, OCP and OPP have to be acknowledged (also see "3.6.2. Device alarm and event handling"). Acknowledgment is done with pin REM-SB switching the DC input off and on again, that's means a HIGH-LOW-HIGH edge (min. 50ms for LOW), when using the default level setting for this pin.

The same is required for PF and OT in case in group "DC input" the corresponding settings "State after PF alarm" or "State after OT alarm" are set to "Off".

3.5.4.3 Analog interface specification

Pin	Name	Type*	Description	Default levels	Electrical specifications
1	VSEL	AI	Voltage set value	0...10 V or. 0...5 V correspond to 0..100% of U_{Nom}	Accuracy 0-5 V range: < 0.4% ***** Accuracy 0-10 V range: < 0.2% *****
2	CSEL	AI	Current set value	0...10 V or. 0...5 V correspond to 0..100% of I_{Nom}	Input impedance $R_i > 40\text{ k} \dots 100\text{ k}$
3	VREF	AO	Reference voltage	10 V or 5 V	Tolerance < 0.2% at $I_{max} = +5\text{ mA}$ Short-circuit-proof against AGND
4	DGND	POT	Ground for all digital signals		For control and status signals
5	REMOTE	DI	Switching internal / remote control	Remote = LOW, $U_{Low} < 1\text{ V}$ Internal = HIGH, $U_{High} > 4\text{ V}$ Internal = Open	Voltage range = 0...30 V $I_{Max} = -1\text{ mA}$ at 5 V $U_{LOW\text{ to }HIGH\text{ typ.}} = 3\text{ V}$ Rec'd sender: Open collector against DGND
6	ALARMS 1	DO	Overheating / power fail alarm	Alarm OT= HIGH, $U_{High} > 4\text{ V}$ No Alarm OT= LOW, $U_{Low} < 1\text{ V}$	Quasi open collector with pull-up against V_{cc} ** With 5 V on the pin max. flow +1 mA $I_{Max} = -10\text{ mA}$ at $U_{CE} = 0,3\text{ V}$ $U_{Max} = 30\text{ V}$ Short-circuit-proof against DGND
7	RSEL	AI	Resistance value	0...10 V or. 0...5 V correspond to $R_{Min} \dots R_{Max}$	Accuracy 0-5 V range: < 0.4% ***** Accuracy 0-10 V range: < 0.2% *****
8	PSEL	AI	Power set value	0...10 V or. 0...5 V correspond to 0..100% of P_{Nom}	Input impedance $R_i > 40\text{ k} \dots 100\text{ k}$
9	VMON	AO	Actual voltage	0...10 V or. 0...5 V correspond to 0..100% of U_{Nom}	Accuracy 0-5 V range: < 0.4% ***** Accuracy 0-10 V range: < 0.2% *****
10	CMON	AO	Actual current	0...10 V or. 0...5 V correspond to 0..100% of I_{Nom}	$I_{Max} = +2\text{ mA}$ Short-circuit-proof against AGND
11	AGND	POT	Ground for all analog signals		For xSEL, xMON and VREF
12	R-ACTIVE	DI	R mode on / off	Off = LOW, $U_{Low} < 1\text{ V}$ On = HIGH, $U_{High} > 4\text{ V}$ On = Open	Voltage range = 0...30 V $I_{Max} = -1\text{ mA}$ at 5 V $U_{LOW\text{ to }HIGH\text{ typ.}} = 3\text{ V}$ Rec'd sender: Open collector against DGND
13	REM-SB	DI	DC input OFF (DC input ON) (ACK alarms *****)	Off = LOW, $U_{Low} < 1\text{ V}$ On = HIGH, $U_{High} > 4\text{ V}$ On = Open	Voltage range = 0...30 V $I_{Max} = +1\text{ mA}$ at 5 V Rec'd sender: Open collector against DGND
14	ALARMS 2	DO	Overvoltage alarm Overcurrent alarm Overpower alarm	Alarm = HIGH, $U_{High} > 4\text{ V}$ No alarm = LOW, $U_{Low} < 1\text{ V}$	Quasi open collector with pull-up against V_{cc} ** With 5 V on the pin max. flow +1 mA $I_{Max} = -10\text{ mA}$ at $U_{CE} = 0,3\text{ V}$, $U_{Max} = 30\text{ V}$ Short-circuit-proof against DGND
15	STATUS***	DO	Constant voltage regulation active DC input	CV = LOW, $U_{Low} < 1\text{ V}$ CC/CP/CR = HIGH, $U_{High} > 4\text{ V}$ Off = LOW, $U_{Low} < 1\text{ V}$ On = HIGH, $U_{High} > 4\text{ V}$	

* AI = Analog Input, AO = Analog Output, DI = Digital Input, DO = Digital Output, POT = Potential

** Internal V_{cc} approx. 10 V

*** Only one of both signals possible, see section 3.4.3.1

**** Only during remote control

***** The error of a set value input adds to the general error of the related value on the DC input of the device

3.5.4.4 Resolution and sample rate

The analog interface is internally sampled and processed by a digital micro-controller. This causes a limited resolution of analog steps. The effective resolution is the same for set values (VSEL etc.) and actual values (VMON/CMON). It's 26214 steps when working with the 10 V range. In the 5 V range this resolution halves. Due to tolerances, the truly achievable resolution can be slightly lower.

3.5.4.5 Overview of the D-sub socket

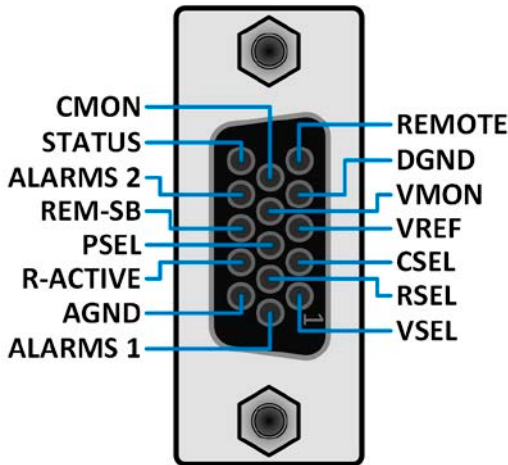

3.5.4.6 Simplified diagram of the pins

	<p>Digital Input (DI) It requires to use a switch with low resistance (relay, switch, circuit breaker etc.) in order to send a clean signal to the DGND.</p>		<p>Analog Input (AI) High resistance input (impedance >40 kΩ) for an operation amplifier circuit.</p>
	<p>Digital Output (DO) A quasi open collector, realized as high resistance pull-up against the internal supply. In condition LOW it can't drive any load, only sink small current, as shown in the diagram with a relay as example.</p>		<p>Analog Output (AO) Output from an operation amplifier circuit, low impedance. See specifications table above.</p>

3.5.4.7 Application examples

a) Switching the DC input with pin REM-SB

! A digital output, e.g. from a PLC, may be unable to cleanly pull down the pin as it may not be of sufficiently low resistance. Check the specification of the controlling application. Also see pin diagrams above.

In remote control, pin REM-SB is used to switch the DC input of the device on and off. This function is also available without remote control being active and can on the one hand block the DC input from being switched on in manual or digital remote control and on the other hand the pin can switch the DC input on or off, but not standalone. See below at "Remote control has not been activated".

It's recommended that a low resistance contact such as a switch, relay or transistor is used to switch the pin to ground (DGND).

Following situations can occur:

- **Remote control has been activated**

During remote control via analog interface, only pin REM-SB determines the states of the DC input, according to the level definitions in 3.5.4.3. The logical function and the default levels can be inverted by a parameter in the setup menu of the device. See 3.4.3.1.

! If the pin is unconnected or the connected contact is open, the pin will be HIGH. With setting "Analog interface" -> "REM-SB level" being set to "Normal", it requests to switch the DC input on. So when activating remote control, the DC input will instantly switch on.

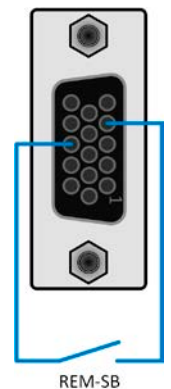

• **Remote control has not been activated**

In this mode of operation pin REM-SB can serve as lock, preventing the DC input from being switched on by any means. This results in following possible situations:

DC terminal	+	Level on pin „REM-SB“	+	Parameter „REM-SB Level“	→ Behavior
is off	+	HIGH	+	Normal	→ The DC input isn't locked. It can be switched on by pushbutton "On/Off" (front panel) or via command from digital interface.
		LOW	+	Inverted	
	+	HIGH	+	Inverted	→ The DC input is locked. It can't be switched on by pushbutton "On/Off" (front panel) or via command from digital interface. When trying to switch on, a pop-up in the display resp. an error message will be generated.
		LOW	+	Normal	

In case the DC input is already switched on, toggling the pin will switch the DC input off, similar to what it does in analog remote control:

DC terminal	+	Level on pin „REM-SB“	+	Parameter „Rem-SB level“	→ Behavior
is on	+	HIGH	+	Normal	→ The DC input remains on, nothing is locked. It can be switched on or off by pushbutton or digital command.
		LOW	+	Inverted	
	+	HIGH	+	Inverted	→ The DC input will be switched off and locked. Later it can be switched on again by toggling the pin. During lock, pushbutton or digital command can delete the request to switch on by pin.
		LOW	+	Normal	

b) Remote control of current and power

Requires remote control to be activated (Pin REMOTE = LOW)

The set values PSEL and CSEL are generated from, for example, the reference voltage VREF, using potentiometers for each. Hence the electronic load can selectively work in current limiting or power limiting mode. According to the specification of max. 5 mA for the VREF output, potentiometers of at least 10 kΩ must be used.

The voltage set value VSEL is directly connected to AGND and will thus be permanently 0%, so constant voltage won't interfere.

If the control voltage is fed in from an external source it's necessary to consider the input voltage ranges for set values (0...5 V oder 0...10 V).

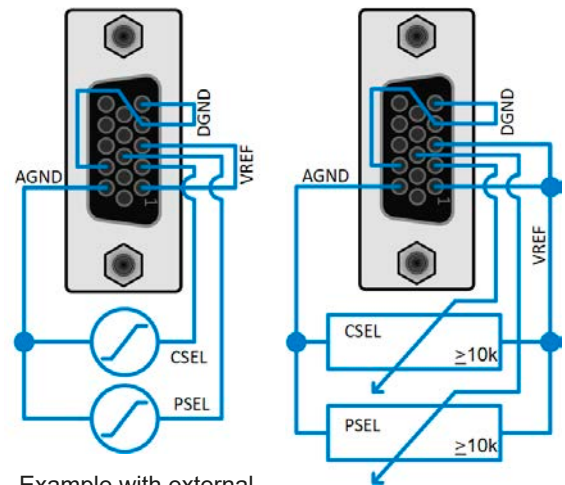

Example with external voltage source

Example with potentiometers



When using the voltage range 0...5 V the effective resolution of set values and actual values halves.

c) Reading actual values

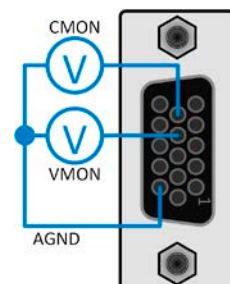

The AI provides the DC input values as current and voltage monitor. These can be read using a standard multimeter or similar.



3.6 Alarms and monitoring

3.6.1 Definition of terms

There is a clear distinction between device alarms (see “3.3. Alarm conditions”), such as overvoltage protection **OVP** or overheating protection, and user defined events such as **OVD** (overvoltage detection). Whilst device alarms only switch off the DC input, user defined events can do more. They can also switch off the DC input (**Action = Alarm**), but can alternatively simply give an acoustic signal to make the user aware. The actions driven by **user defined events** can be selected:

Action	Impact	Example
None	User defined event is disabled.	
Signal	On reaching the condition which triggers the event, the action Signal will show a text message in the status area of the display.	
Warning	On reaching the condition which triggers the event, the action Warning will show a text message in the status area of the display and pop up an additional warning message.	
Alarm	On reaching the condition which triggers the event, the action Alarm will show a text message in the status area of the display with an additional alarm pop-up, and additionally emit an acoustic signal (if activated). Furthermore the DC input is switched off. Most of the device alarms are signaled on the analog interface, while all can be queried via the digital interfaces.	

3.6.2 Device alarm and event handling



Important to know:
When switching the DC input of the device off while a current limited source still supplies energy, the output voltage of the source can rise immediately and due to transient times the output voltage can have an overshoot to an unknown level which might trigger the overvoltage alarm (OVP) or the overvoltage supervision event (OVD) of the device in case these thresholds are adjusted to sensitive levels.

A device alarm incident will usually lead to DC input switch-off, the appearance of a pop-up in the middle of the display and, if activated, an acoustic signal to make the user aware. An alarm must always be acknowledged.

► **How to acknowledge an alarm in the display (during manual control)**

1. If the alarm is indicated as a pop-up, tap **Acknowledge**.
2. If the alarm has already been acknowledged, but is still displayed in the status area, then first tap the status area to display the pop-up, and then **Acknowledge**.

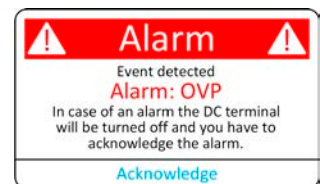

In order to acknowledge an alarm during analog remote control refer to “3.5.4.2. Acknowledging device alarms”. To acknowledge in digital remote, refer to the external documentation “Programming ModBus & SCPI”.

Some device alarms are configurable:

Short	Long	Description	Range	Indication
OVP	OverVoltage Protection	Triggers an alarm if the voltage on the DC input reaches the defined threshold. The DC input will be switched off. However, this doesn't protect the device from being damaged due to persistent overvoltage.	0 V...1.1*U _{Nom}	Display, analog & digital interfaces
OCP	OverCurrent Protection	Triggers an alarm if the current in the DC input reaches the defined threshold. The DC input will be switched off.	0 A...1.1*I _{Nom}	Display, analog & digital interfaces
OPP	OverPower Protection	Triggers an alarm if the input power reaches the defined threshold. The DC input will be switched off.	0 W...1.1*P _{Nom}	Display, analog & digital interfaces

These device alarms can't be configured and are based on hardware:

Short	Long	Description	Indication
PF	Power Fail	AC supply over- or undervoltage. Triggers an alarm if the AC supply is out of specification or when the device is cut from supply, for example when switching it off with the power switch. The DC input will be switched off.	Display, analog & digital interfaces
OT	OverTemperature	Triggers an alarm if the internal temperature reaches a certain limit. The DC input will be switched off.	
MSP	Master-Slave Protection	Triggers an alarm if the master unit loses contact to any slave unit. The DC input will be switched off. The alarm can be cleared by reinitializing the MS system.	Display, digital interfaces
SF	Share Bus Fail	Share bus fail. Can occur in situation where too many devices are connected on their Share bus connectors or, more likely, the cabling is dampening too much due to wrong or damaged (short-circuit) BNC cables. For details also see 3.3.6.	

► How to configure the thresholds of the adjustable device alarms



1. While the DC input is switched off tap the touch area  on the main screen.
Settings
2. In the menu tap on group "**Protection**". On the right-hand side of the screen it will list all device alarms with their adjustable thresholds. These are permanently compared to the actual values of voltage, current and power on the DC input.
3. Set the threshold for the protections relevant to your application if the default value of 110% is unsuitable.

The user also has the possibility of selecting whether an additional acoustic signal will be sounded if an alarm or user defined event occurs.

► How to configure the alarm sound (also see "3.4.3. Configuration via the menu")

1. Swipe with your finger up from the bottom edge of the screen or directly tap on the bottom bar:



2. The quick menu will open. Tap on  to activate the alarm sound, or on  to deactivate it.
3. Leave the quick menu.

3.6.2.1 User defined events

The monitoring functions of the device can be configured for user defined events. By default, events are deactivated (**Action** set to **None**). Contrary to device alarms, the events only work while the DC input is switched on. It means, for instance, that you cannot detect undervoltage (UVD) anymore after switching the DC input off and the source lower it.

The following events can be configured independently:

Event	Meaning	Description	Range
UVD	UnderVoltage Detection	Triggers an event if the DC voltage falls below the defined threshold.	$0 V \dots U_{Nom}$
OVD	OverVoltage Detection	Triggers an event if the DC voltage exceeds the defined threshold.	$0 V \dots U_{Nom}$
UCD	UnderCurrent Detection	Triggers an event if the DC current falls below the defined threshold.	$0 A \dots I_{Nom}$
OCD	OverCurrent Detection	Triggers an event if the DC current exceeds the defined threshold.	$0 A \dots I_{Nom}$
OPD	OverPower Detection	Triggers an event if the DC power exceeds the defined threshold.	$0 W \dots P_{Nom}$



These events should not be confused with alarms such as OT and OVP which are for device protection. User defined events can, however, if set to action Alarm, switch off the DC input and thus protect the source.

► How to configure user defined events

1. While the DC input is switched off tap touch area  on the main screen.
Settings
2. On the left side tap on group "**User events**". It will then let you access all user definable events on the right-hand side. The values you can adjust there are thresholds which permanently compared to the actual values of voltage, current and power on the DC input while it's on.
3. Tap on the values to adjust them with the numeric pad popping up. The adjustable range is here not restricted by the "Limits". The "Action" for every event is set with a drop-down selector. See "3.6.1. Definition of terms" for the meaning of the actions.



User events are part of the profiles. Thus, if another user profile or the default profile is selected and used, the events could either be differently configured or not at all.

3.7 Locking the control panel (HMI)

In order to avoid the accidental alteration of a value during manual operation the rotary knobs or the touchscreen can be locked so that no alteration of values will be accepted without prior unlocking.

► How to lock the HMI

1. In the main page, tap the lock symbol  (upper right corner). If the DC input is switched on in this moment, the lock is immediately effective.
2. Otherwise the “**Lock**” screen will appear where you can select to lock the HMI completely or with the exception of the button “**On/Off**” by enabling “**On/Off possible during HMI lock**”. Additionally, you can decide to activate the additional “**PIN for user interface lock**”. The device would later request to enter this PIN every time you want to unlock the HMI.
3. Activate the lock with **Start**. The device will jump back to the main screen and dim it.

If an attempt is made to tap the screen or rotate a knob whilst the HMI is locked, a requester appears in the display asking if the lock should be disabled.

► How to unlock the HMI

1. Tap any area on the touchscreen or rotate any knob or press the button “**On/Off**” (only in full lock).

2. This request pop-up will appear:

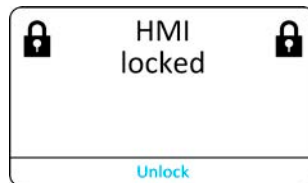

3. Unlock the HMI by tapping on **Unlock** within 5 seconds, otherwise the pop-up will disappear and the HMI remains locked. In case the additional PIN code lock has been activated in the “**Lock**” screen, another requester will pop up, asking you to enter the PIN before it finally unlocks the HMI.

3.8 Locking the “Limits” and “Profiles”

In order to avoid the alteration of the adjustment limits (also see “3.4.4. Adjustment limits”) by an unprivileged user, the screen with the adjustment limit settings (“Limits”) can be locked by a PIN code. This will lock group “**Limits**” in the “**Settings**” menu and menu “**Profiles**” until the lock is removed by entering the correct PIN or, in case it has been forgotten, by resetting the device to factory default.

► How to lock the Limits and Profiles

1. Tap touch area  on the main screen. In case the HMI is also locked, it has to be unlocked first, probably by entering the PIN. After this, menu page “**Lock**” will be entered.
2. In the switch next to “**Lock limits and profiles with user PIN**”.
3. Leave the “**Settings**” menu.



The same PIN as for the HMI lock is used here. It should be set before activating the Limits lock. See “3.7. Locking the control panel (HMI)”



Be careful to enable the lock if you are unsure what PIN is currently set. In doubt use ESC to exit the menu page. In menu page “**Lock**” you can define a different PIN, but not without entering the old one.

► How to unlock the Limits and Profiles

1. While the DC input is switched off, tap touch area  on the main screen.
Menu
2. In the menu tap on “**HMI setup**”, then on group “**Lock**”.
3. In the group tap on “**Unlock limits and profiles**”. You will be requested to enter the 4-digit PIN.
4. Deactivate the lock by entering the correct PIN.

3.9 Loading and saving user profiles

The menu “**Profiles**” serves to select between a default profile and up to 5 user profiles. A profile is a collection of all settings and set values. Upon delivery or after a factory reset all 6 profiles have the same settings and all set values are 0. Values adjusted on the main screen or anywhere else belong to a working profile which can be saved to one of the 5 user profiles. These user profiles or the default profile can then be switched. The default profile is read-only.

The purpose of a profile is to load a set of set values, settings limits and monitoring thresholds quickly without having to readjust these. As all HMI settings are saved in the profile, including language, a profile change can also be accompanied by a change in HMI language.

On calling up the menu page and selecting a profile the most important settings can be seen, but not changed.

► How to save the current values and settings as a user profile:

1. While the DC input is switched off, tap touch area



on the main screen.

2. In the main menu tap on “**Profiles**”.
3. In the next screen (see example to the right) choose between user profiles 1-5, which will show the profile’s stored settings for your verification.
4. Tap on **Save/Load** and save the settings into the user profile in the popping up requester “Save profile?” with **Save**.

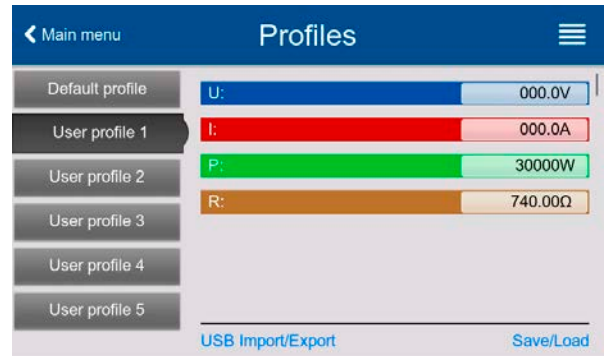

*All user profiles also allow to just edit some settings or values stored in the profile. When doing so, the changes either need to be saved to the profile with **Save changes** or discarded with **Cancel** before the profile can be loaded.*

Loading a user profile works the same way, but in the requester you would then tap **Load** under “Load profile?”. Alternatively, you may import the profile or export it as file to an USB stick with **USB Import/Export**.

3.10 The function generator

3.10.1 Introduction

The built-in **function generator** (short: **FG**) is able to create various signal forms and apply these to the set value of either voltage or current.

The standard functions are based on an **arbitrary generator** and directly accessible and configurable using manual control. In remote control, the fully customizable arbitrary generator replicates these functions with sequence points containing 8 parameters each.

The so-called IU function is based on an **XY generator** that works with a table of 4096 values which are loaded from an USB stick. The following functions are retrievable, configurable and controllable:

Function	Short description
Sine wave	Sine wave generation with adjustable amplitude, offset and frequency
Triangle	Triangular wave signal generation with adjustable amplitude, offset, rise and fall times
Rectangular	Rectangular wave signal generation with adjustable amplitude, offset and duty cycle
Trapezoid	Trapezoidal wave signal generation with adjustable amplitude, offset, rise time, pulse time, fall time, idle time
DIN 40839	Simulated automobile engine start curve according to DIN 40839 / EN ISO 7637, split into 5 curve sequences, each with a start voltage, final voltage and time
Arbitrary	Generation of a process with up to 99 freely configurable curve points, each with a start and end value (AC/DC), start and end frequency, phase angle and total duration
Ramp	Generation of a linear rise or fall ramp with start and end values and time before and after the ramp
IU	XY generator, USB stick loadable current curve (table, CSV)
Battery test	Battery discharge test with constant or pulsed current, along with Ah, Wh and time counters
MPP Tracking	Simulation of the characteristic tracking behavior of solar inverters when seeking to find the maximum power point (MPP) when being connected to typical sources such as solar panels

3.10.2 General

3.10.2.1 Limitations

The function generator isn't accessible, neither for manual access nor for remote control, if resistance mode (R mode, also called UIR) is active.

3.10.2.2 Resolution

Amplitudes generated by the arbitrary generator have an effective resolution of approx. 52428 steps. If the amplitude is very low and the time long, the device would generate less steps and set multiple identical values after another, generating a staircase effect. It's furthermore not possible to generate every possible combination of time and a varying amplitude (slope).

3.10.2.3 Minimum slope / maximum ramp time

When using a rising or falling offset (i.e. DC part) in functions like ramp, trapezoid and triangle, a minimum slope calculated from the rated values of voltage or current is required or else the adjusted settings would be neglected by the device. Calculating the minimum slope can help to determine if a certain ramp over time can be achieved by the device or not. Example: model PSB 10200-420 is going to be used, with 200 V and 420 A rating. **Formula: minimum slope = 0.000725 * rated value / s.** For the example model it results in $\Delta U/\Delta t$ of 145 mV/s and $\Delta I/\Delta t$ of 304 mA/s. The maximum time which can be achieved with the minimum slope always calculates as approximately 1379 seconds according to formula $t_{\text{Max}} = \text{rated value} / \text{min. slope}$.

3.10.3 Method of operation

In order to understand how the function generator works and how the value settings interact, the following should be noted:

The device operates always with the three set values U, I and P, also in function generator mode.

The selected function can be used on one of the values U or I, the other two are then constants and have a limiting effect. That means, if, e.g. a voltage of 40 V is applied to the DC input and a sine wave function should operate on the current with an amplitude of 200 A and offset 200 A, then the function generator will create a sine wave progression of current between 0 A (min) and 400 A (max), which will result in an input power between 0 W (min) and 16000 W (max). The input power, however, is limited to its set value. If this were 12000 W then, in this case, the current would be limited to 300 A and, if clamped to an oscilloscope, it would be seen to be capped at 300 A and never achieve the target of 400 A.

Another case is when working with a function which is applied to the input voltage. If here the static voltage is set higher than the amplitude plus offset then at function start there will be no reaction, as the voltage regulation limits down to 0 with an electronic load, other than current or power. The correct settings for each of the other set values is therefore essential.

Master-slave systems have further characteristics which have to be considered:



At the end of the configuration, after the function has been loaded and the screen shows the main view of the function generator, there are adjustable set values, the so-called “U/I/P limits”. These limits are transferred to all slave units of master-slave systems. It’s recommended to carefully configure them so the MS system can work as expected and the slaves wouldn’t impact the function run in a negative way.

3.10.4 Manual operation

3.10.4.1 Function selection and control

All the functions listed in 3.10.1 can be called on the touch screen, configured and controlled. Selection and configuration are only possible while the DC input is switched off.

► How to select a function and adjust parameters

1. While the DC input is switched off tap touch area



Func Gen on the main screen. Note: this icon is locked as long as resistance mode (R mode) is enabled.

2. In the menu select the desired function by tapping on the list on the left-hand side. Depending on the choice of function there follows a request to which value the function generator is going to be applied, **Voltage** or **Current**.
3. Adjust the parameters as you desire.
4. Adjust the overall limits of voltage, current and power, then continue with .
5. As last part of the configuration, global set values have to be defined which are considered as static values and come into effect before and after the function run. Correct setup here is important, especially when running the function on a master device of a master-slave system.



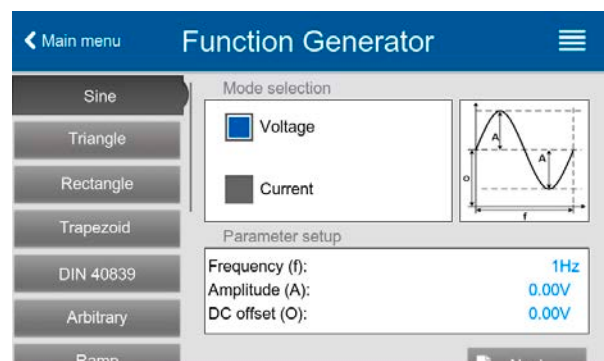

The global limits of U, I and P become instantly active when coming to the main screen of the function generator, because the DC input is then switched on automatically to settle the start situation. This can be helpful when wanting a function shall not start at 0 V or 0 A. In case the situation requires otherwise, the static values could also be set to 0.

6. Exit the configuration and enter the main function generator screen with .



Setting the various functions and their parameters is described below. After the function generator screen has been reached, the function is ready to run. Before and while the function is running, some global and also some function related values can be adjusted anytime.

► How to start and stop a function

1. The function can be **started** either by tapping  or if the DC input is currently switched off by pushing the “On/Off” button on the front.
2. The function can either be **stopped** by tapping  or operating the “On/Off” button. However, there is a difference:
 - a) The  button only stops the function while the DC input remains ON with the static values in effect.
 - b) The “On/Off” button stops the function and switches the DC input off.

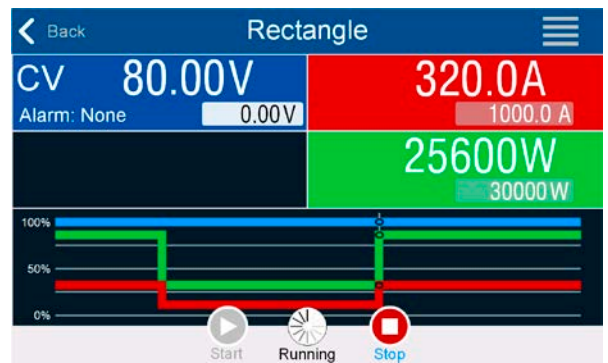

Any device alarm (power fail, overtemperature etc.), protection (OPP, OCP) or event with Action = Alarm stops the function progress automatically, switches off the DC input and reports the alarm.

3.10.5 Sine wave function

The following parameters can be configured for a sine function:

Parameter	Range	Description
Frequency (f)	1...10000 Hz	Static frequency of the signal to be generated
Amplitude (A)	0...(rated value - Offset) of U or I	Amplitude of the signal to be generated
Offset (O)	0... (U _{Nom} - A) or 0...(I _{Nom} - A)	Offset from the zero point of the mathematical sine curve

Schematic diagram:

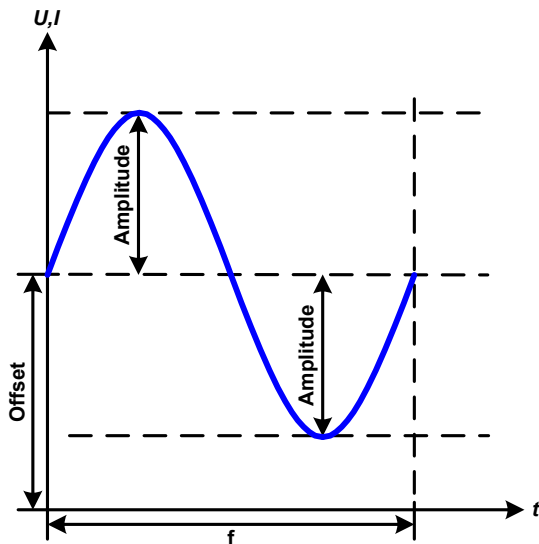

Application and result:

A normal sine wave signal is generated and applied to the selected set value, e.g. current (I). At a constant input voltage the current input of the load will follow a sine wave.

For calculating the maximum power input the amplitude and offset values for the current must be added.

Example: with an input voltage of 100 V and sin(I) selected, set the amplitude to 30 A and the offset to 50 A. The resulting maximum input power is then achieved at the highest point of the sine wave and is $(30 \text{ A} + 50 \text{ A}) * 100 \text{ V} = 8000 \text{ W}$.

3.10.6 Triangular function

The following parameters can be configured for a triangular function:

Parameter	Range	Description
Amplitude (A)	0...(rated value - Offset) of U or I	Amplitude of the signal to be generated
Offset (O)	0... (U _{Nom} - A) or 0...(I _{Nom} - A)	Offset, based on the foot of the triangular wave
Time t1	0.1 ms...36,000,000 ms	Rising edge time Δt of the triangular wave signal
Time t2	0.1 ms...36,000,000 ms	Falling edge time Δt of the triangular wave signal

Schematic diagram:

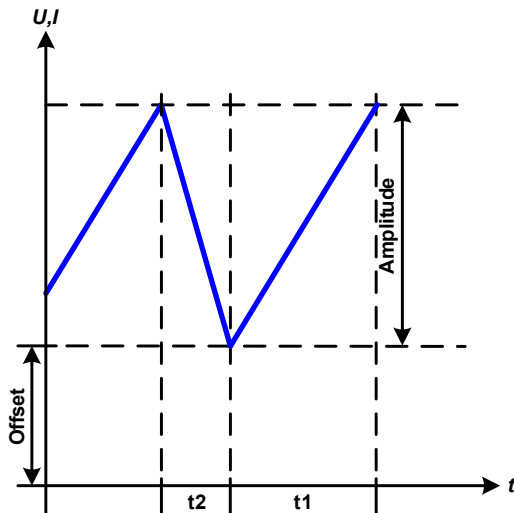

Application and result:

A triangular wave signal for use on the current or voltage is generated. The positive and negative slope times can be set independently.

The offset shifts the signal on the Y axis.

The sum of the intervals t1 and t2 gives the cycle time and its reciprocal is the frequency.

Example: a frequency of 10 Hz is required and would lead to periodic duration of 100 ms. This 100 ms can be freely allocated to t1 and t2, e.g. 50 ms:50 ms (isosceles triangle) or 99.9 ms:0.1 ms (right-angled triangle or sawtooth).

3.10.7 Rectangular function

The following parameters can be configured for a rectangular function:

Parameter	Range	Description
Amplitude (A)	0...(rated value - Offset) of U or I	Amplitude of the signal to be generated
Offset (O)	0... (U _{Nom} - A) or 0...(I _{Nom} - A)	Offset, based on the foot of the rectangular wave
Time t1	0.1 ms...36,000,000 ms	Time (pulse width) of the upper level (amplitude)
Time t2	0.1 ms...36,000,000 ms	Time (pause width) of the lower level (offset)

Schematic diagram:

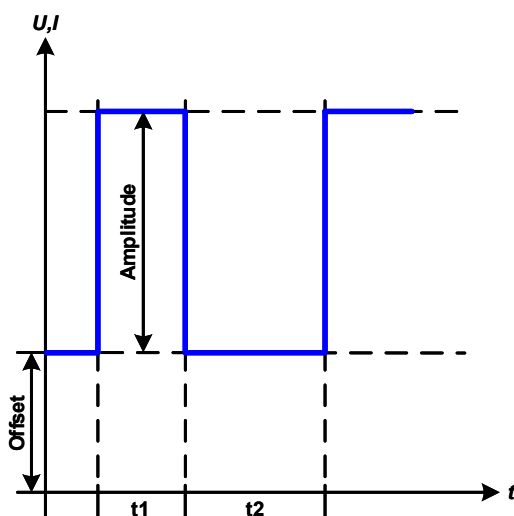

Application and result:

A rectangular or square wave signal for use on the current or voltage is generated. The intervals t1 and t2 define how long the value of the amplitude (pulse) and how long the value of the offset (pause) are effective.

The offset shifts the signal on the Y axis.

Intervals t1 and t2 can be used to define a duty cycle. The sum of t1 and t2 gives the period and its reciprocal the frequency.

Example: a rectangular wave signal of 25 Hz and a duty cycle of 80% are required. The sum of t1 and t2, the period, is $1/25 \text{ Hz} = 40 \text{ ms}$. For a duty cycle of 80% the pulse time (t1) is $40 \text{ ms} \cdot 0.8 = 32 \text{ ms}$ and the pause time (t2) is 8 ms

3.10.8 Trapezoidal function

The following parameters can be configured for a trapezoidal function:

Parameter	Range	Description
Amplitude (A)	0...(rated value - Offset) of U or I	Amplitude of the signal to be generated
Offset (O)	0... (U _{Nom} - Amplitude) or 0...(I _{Nom} - Amplitude)	Offset, based on the foot of the trapezium
Time t1	0.1 ms...36,000,000 ms	Time for the positive slope of the trapezoidal wave signal.
Time t2	0.1 ms...36,000,000 ms	Time for the top value of the trapezoidal wave signal.
Time t3	0.1 ms...36,000,000 ms	Time for the negative slope of the trapezoidal wave signal.
Time t4	0.1 ms...36,000,000 ms	Time for the base value (=offset) of the trapezoidal wave signal

Schematic diagram:

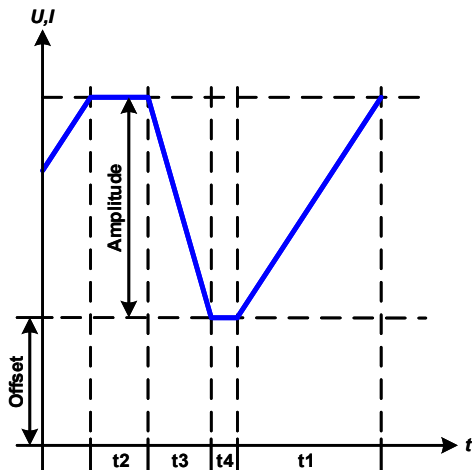

Application and result:

Same as with other functions the generated signal can be applied to the set value of voltage (U mode) or to the current (I mode). The slopes of the trapezium can be varied by adjusting the times for rise and fall separately.

The periodic duration and repetition frequency are the result of the four adjustable time values. With suitable settings the trapezium can be deformed to two triangular or two rectangular pulses. It has, therefore, universal use.

3.10.9 DIN 40839 function

This function is based on the curve defined in DIN 40839 / EN ISO 7637 (test impulse 4), and is only applicable to voltage. It shall replicate the progress of automobile battery voltage during engine starting. The curve is divided into 5 parts (see diagram below) which each have the same parameters. The standard values from the DIN are set already as default values for the five sequences.

The following parameters can be configured for the single sequence points or the entire function:

Parameter	Range	Seq	Description
Start	0...U _{Nom}	1-5	Start voltage of the ramp in part 1-5 (sequence point)
End	0...U _{Nom}	1-5	End voltage of the ramp in part 1-5 (sequence point)
Time	0.1 ms...36,000,000 ms	1-5	Time of the ramp
Cycles	0 / 1...999	-	Number of times to run the entire curve (0 = infinite)
Time t1	0.1 ms...36,000,000 ms	-	Time after cycle before repetition (cycle <> 1)
U(Start/End)	0...U _{Nom}	-	Voltage setting before and after the function run
I/P	0...I _{Nom} /P _{Nom}	-	Set values of current and power

Schematic diagram:

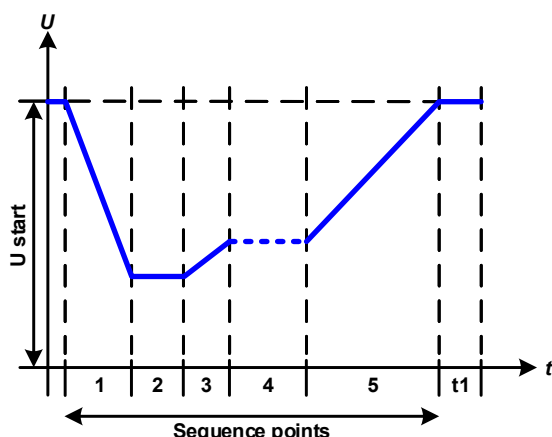

Application and result:

The function's primary use is to load a source, for instance a power supply, which cannot generate the curve itself and would supply a static DC voltage. The load acts as a sink for the rapid fall of the output voltage of the power supply enabling the voltage progress to follow the DIN curve. The only requirement for the source is that it features (an adjustable) current limitation.

The curve conforms to test impulse 4 of the DIN. With suitable settings, other test impulses can be simulated. If the curve in sequence 4 should be a sine wave, then these 5 sequence points would have to be reconstructed using the arbitrary generator.

3.10.10 Arbitrary function

The arbitrary (freely definable) function or function generator offers the user a wider scope of options. There are 99 curve segments (here: sequence points) available for use on either current (I) or voltage (U), all of which have the same set of parameters but can be differently configured, so that a complex function curve can be “constructed”. An arbitrary number out of the 99 sequence points can run in a sequence point block and this block can then be repeated up to 999 times or infinitely. Since the function must be assigned to either current or voltage, mix assignments of sequence point to both isn't possible.

The arbitrary curve can overlay a linear progression (DC) with a sine curve (AC) whose amplitude and frequency is shaped between start and end. When both, start frequency and end frequency, are 0 Hz the AC overlay has no impact and only the DC part is effective. Each sequence point is allocated a sequence point time in which the AC/DC curve from start to end will be generated.

The following parameters can be configured for each sequence point in the arbitrary function:

Parameter	Range	Description
AC start	-50%...+50% I_{Nom} or	Start and end amplitude of the sinusoidal AC part
AC end	0%...50% U_{Nom}	
DC start	AC start...(rated value - AC start)	Start level (offset) of the DC part
DC end	AC end...(rated value - AC end)	End level (offset) of the DC part
Start frequency	0 Hz...10000 Hz	Start frequency of the sinusoidal AC part
End frequency	0 Hz...10000 Hz	End frequency of the sinusoidal AC part
Angle	0°...359°	Start angle of the sinusoidal AC part
Time	0.1 ms...36,000,000 ms	Time setting for the selected sequence point



The sequence point time (“Time”) and the start and end frequency are related. The minimum value for $\Delta f/s$ is 9.3. Thus, for example, a setting of start frequency = 1 Hz, end frequency = 11 Hz and time = 5 s would not be accepted as $\Delta f/s$ is only 2. A time of 1 s would be accepted or, if the time remains at 5 s, then an end frequency = 51 Hz must be set.



The amplitude change between start and end is related to the sequence time. A minimal change over an extended time isn't possible and in such a case the device will report an inapplicable setting.

Further down in the configuration screen are global settings for all 99 points adjustable:

Parameter	Range	Description
Cycles	0 / 1...999	Number of cycles to run the sequence point block (0 = infinite)
Start sequence	1...End sequence	First sequence point in the block
End sequence	Start sequence...99	Last sequence point in the block

Schematic diagram:

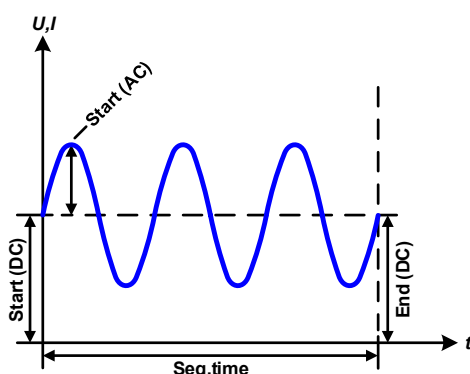

Applications and results:

Example 1

Focusing 1 cycle of 1 sequence point:

DC values for start and end are the same, also the AC amplitude. With a frequency >0 Hz a sine wave progression of the set value is generated with a defined amplitude, frequency and Y axis offset (DC values for start and end).

The number of sine waves per cycle depends on the sequence point time and the frequency. If the time was 1 s and the frequency 1 Hz, there would be exactly one sine wave. If the time was 0.5 s at the same frequency, there would only be a half sine wave.

Schematic diagram:

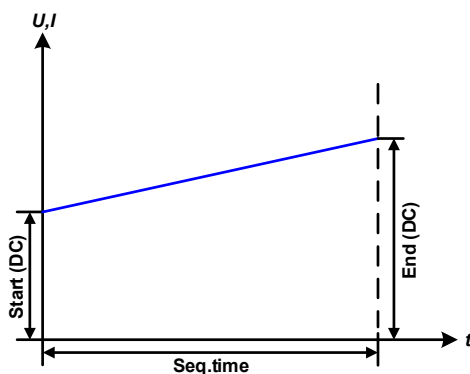
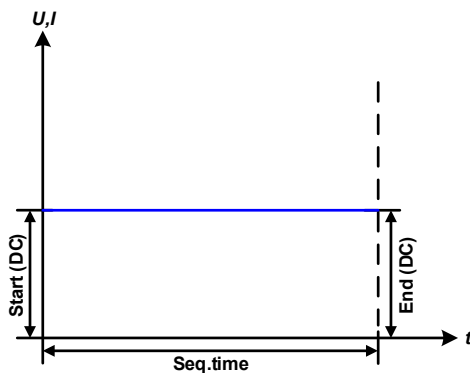
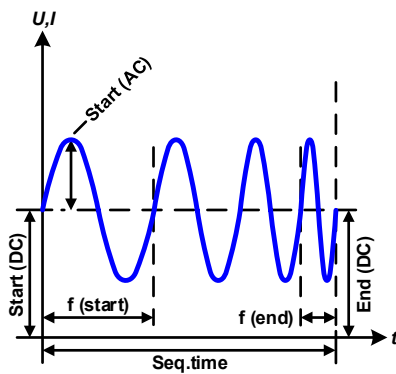
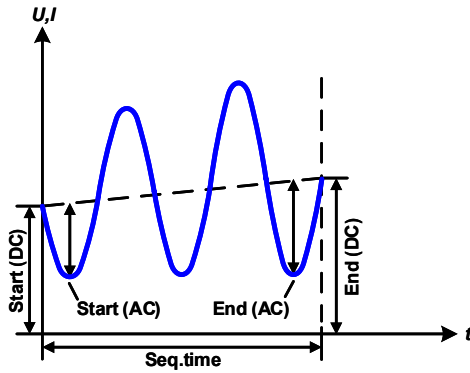
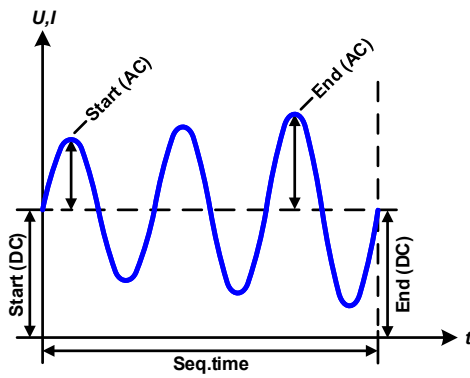

Applications and results:

Example 2

Focusing 1 cycle of 1 sequence point:

The DC values at start and end are the same but those of the amplitude aren't. The end value is higher than the start value so the amplitude increases with each new half sine wave continuously over the sequence point time. This, of course, only if time and frequency allow for multiple waves to be created. For instance, with $f=1$ Hz and time = 3 s, three full waves would be generated, if the angle is 0° , and reciprocally the same for $f=3$ s and time=1 s.

Example 3

Focusing 1 cycle of 1 sequence point:

The DC values at start and end are not equal, as well as the AC start and end values. In both cases the end value is higher than the start value so that offset increases over time, but also the amplitude with each new half sine wave.

Additionally, the first sine wave starts with a negative half wave because the angle has been set to 180° . The start angle can be shifted at will in steps of 1° between 0° and 359° .

Example 4

Focusing 1 cycle of 1 sequence point:

Similar to example 1 but with a different end frequency. Here this is shown as higher than the start frequency. This impacts the period of the sine waves such that each new wave will be shorter over the total span of the sequence time.

Example 5

Focusing 1 cycle of 1 sequence point:

Similar to example 1 but with a start and end frequency of 0 Hz. Without a frequency, no sine wave part (AC) will be generated and only the DC settings will be effective. A ramp with a horizontal progression would result.

Example 6

Focusing 1 cycle of 1 sequence point:

Similar to example 1 but with a start and end frequency of 0 Hz. Without a frequency no sine wave part (AC) will be generated and only the DC settings will be effective. Here the DC start and end values are unequal and a steadily increasing ramp would result.

By linking together a number of differently configured sequence points, complex progressions can be created. Smart configuration of the arbitrary generator can be used to match triangular, sine, rectangular or trapezoidal wave functions and thus, e.g. a sequence of rectangular waves with differing amplitudes or duty cycles could be produced.

Schematic diagram:

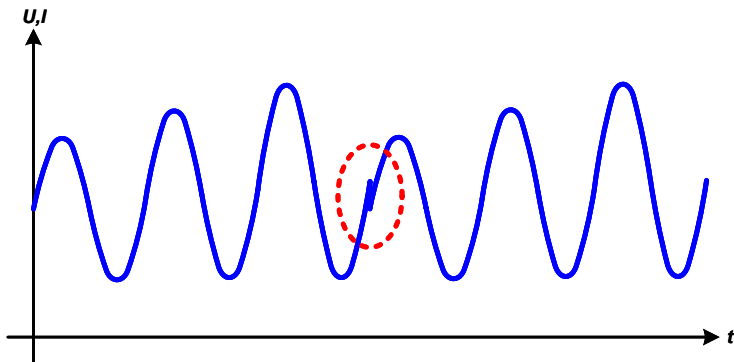

Applications and results:

Example 7

Focusing 2 cycles of 1 sequence point:

One sequence point, configured as in example 3, is run. Since the settings define that the end offset (DC) is higher than the start, the second run will revert to the same start level as the first, regardless of the signal level at the end of the first run. This can produce a discontinuity in the total progression (marked in red) which may only be compensated with a careful choice of settings.

Example 8

Focusing 1 cycle of 2 sequence points:

Two sequence points run consecutively. The first one generates a sine wave with increasing amplitude, the second one with a decreasing amplitude. Together they produce a progression as shown to the left. In order to ensure that the wave peak in the middle occurs only once, the first sequence point must end with a positive half wave and the second one start with a negative half wave as shown in the diagram.

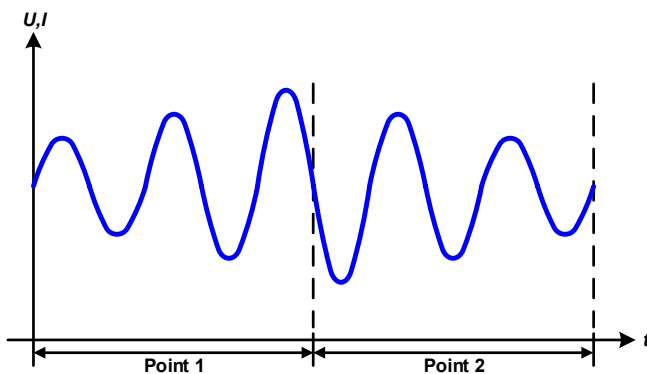

Example 9

Focusing 1 cycle of 4 sequence points:

Point 1: 1/4th sine wave (angle = 270°)

Point 2: Three sine waves (ratio of frequency to time is 1:3)

Point 3: Horizontal ramp (f = 0)

Point 4: Falling ramp (f = 0)

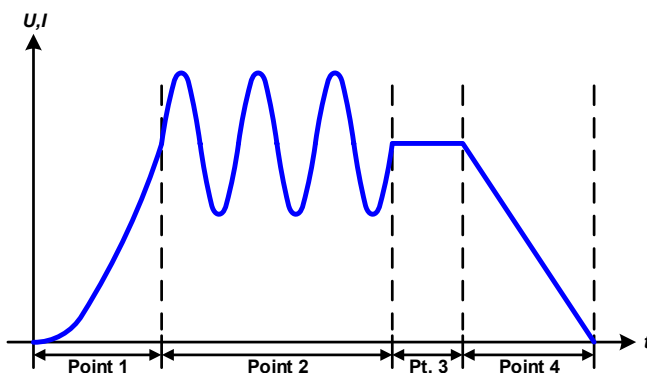

3.10.10.1 Loading and saving the arbitrary function

The 99 sequence points of the arbitrary function, which can be manually configured with the control panel of the device and which are applicable either to voltage (U) or current (I), can be saved to or loaded from a common USB stick via the front side USB port. Generally, all 99 points are saved or loaded at once using a text file of type CSV which represents a table of values.

In order to load a sequence table for the arbitrary generator, following requirements have to be met:

- The table must contain exactly 99 rows with 8 subsequent values (8 columns) and must not have gaps
- The column separator (semicolon, comma) must be as selected by MENU parameter "USB file separator format"; it also defines the decimal separator (dot, comma)
- The files must be stored inside a folder called HMI_FILES which has to be in the root of the USB stick
- The file name must always start with WAVE_U or WAVE_I (not case-sensitive)
- All values in every row and column have to be within the specified range (see below)
- The columns in the table have to be in a defined order which must not be changed

Following value ranges are given for use in the table, related to the manual configuration of the arbitrary generator (column headers like in Excel):

Column	Connected to HMI parameter	Range
A	AC start	See table in "3.10.10. Arbitrary function"
B	AC end	See table in "3.10.10. Arbitrary function"
C	Start frequency	0...10000 Hz
D	End frequency	0...10000 Hz
E	Angle	0...359°
F	DC start	See table in "3.10.10. Arbitrary function"
G	DC end	See table in "3.10.10. Arbitrary function"
H	Time	100...36.000.000.000 µs (36 billion)

For details about the parameter and the arbitrary function refer to "3.10.10. Arbitrary function".

Example CSV:

	A	B	C	D	E	F	G	H
1	20,00	30,00	5	5	90	50,00	50,00	50000000
2	30,00	20,00	5	5	90	50,00	50,00	30000000
3	0,00	0,00	0	0	0	0,00	0,00	1000
4	0,00	0,00	0	0	0	0,00	0,00	1000
5	0,00	0,00	0	0	0	0,00	0,00	1000
6	0,00	0,00	0	0	0	0,00	0,00	1000

The example shows that only the first two sequence points are configured, while all others are set to default values. The table could be loaded as WAVE_U or WAVE_I when using, for example, the model ELR 10080-1000 4U, because the values would fit both, voltage and current. The file naming, however, is unique. A filter prevents you from loading a WAVE_I file after you have selected "Arbitrary --> U" in the function generator menu. The file would not be listed at all.

► How to load a sequence point table from an USB stick:

1. Do not plug the USB stick yet or remove it.
2. While the DC input is switched off, tap on



Func Gen to access the function selection menu. There tap on group "Arbitrary" which will show the settings as shown in the screenshot to the right.

3. Swipe up to go down to the "Sequence setup" part and tap on **Import/Export**, then on **Load** and follow the instructions.

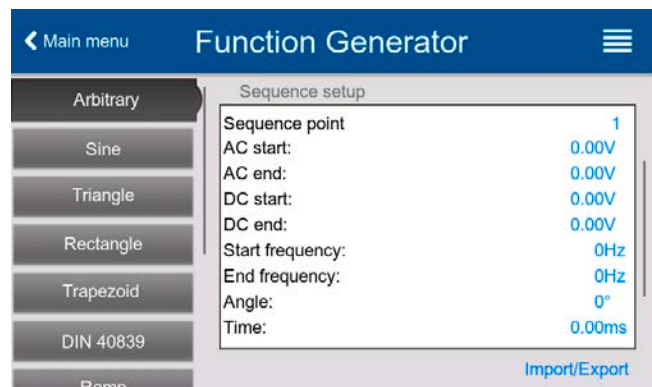

If the file open dialog can at least list one compatible file, it will be listed for selection. Select your desired table.

4. To finally load the file, tap on . The selected file is then checked for validity and loaded. In case of format errors, a message will be shown on screen. The file would have to be checked and tried again.

► How to save a sequence point table to an USB stick:

1. Do not plug the USB stick yet or remove it.

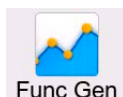

2. While the DC input is switched off, tap on Func Gen to access the function selection menu. There tap on group "Arbitrary" which will show the settings as shown in the screenshot to the right.

3. Swipe up to go down to the "Sequence setup" part and tap on **Import/Export**, then on **Save** and follow the instructions. In the file open dialog you can either select an existing file, if at least one compatible file is listed, or you can create a new one by not selecting any file.

4. Save the file, new or overwriting, with .

3.10.11 Ramp function

The following parameters can be configured for a ramp function:

Parameter	Range	Description
Start End	0... U_{Nom} or 0... I_{Nom}	Start/end point of the ramp. Both values can be equal or different, which then results in either a rising, falling or horizontal ramp
Time t1	0.1 ms...36,000,000 ms	Time before ramp-up or ramp-down of the signal.
Time t2	0.1 ms...36,000,000 ms	Ramp-up or ramp-down time



10 h after reaching the ramp end, the function will stop automatically (i.e. $I = 0 A$, in case the ramp was assigned to the current), unless it has been stopped manually before.

Schematic diagram:

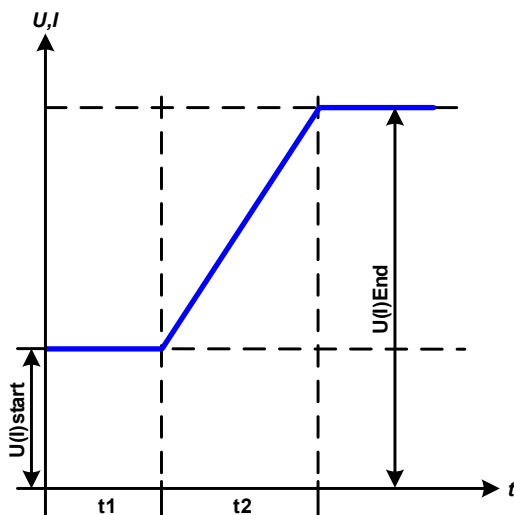

Application and result:

This function generates a rising, falling or horizontally running ramp between the start and end values over time t2. Time t1 creates a delay before the ramp starts.

The function runs once and stops at the end value. To have a repeating ramp, the Trapezoid function would have to be used instead (see 3.10.8).

3.10.12 IU table function (XY table)

The IU function offer the user the possibility to set a DC input current dependent on the DC input voltage. The function is table driven with exactly 4096 values, which are distributed over the whole measured range of actual input voltage in the range of 0...125% U_{nom} , of which only 0...102% are effective. The table can either be uploaded from an USB stick through the front side USB port of the device or via remote control (ModBus RTU protocol or SCPI). The functions are:

IU function: $I = f(U)$

In the **IU function**, an internal measuring circuit measures the voltage on the DC input. For every possible actual voltage on the scale of 0...125% the loaded IU table holds a current value, which can be any value between 0 and rated current. The values uploaded from an USB stick will always be interpreted as current values even if the user calculated them as voltage values and loaded them as an IU table due to wrong file naming.



Uploading of a table from an USB stick must use text files in CSV format (.csv). Plausibility is checked when loading, i.e. values not too high, number of values correct etc. which may abort loading when errors are found.*



The 4096 values in the table are only checked for size and count. If all the values were to be graphically plotted into a curve it could include huge step changes in the current. This could lead to complications for the connected source if, for example, the internal voltage measurement swings slightly so that the current jumps back and forth between a few values in the table which, in the worst case, could be bounce between 0 A and the maximum current.

3.10.12.1 Loading IU tables from USB stick



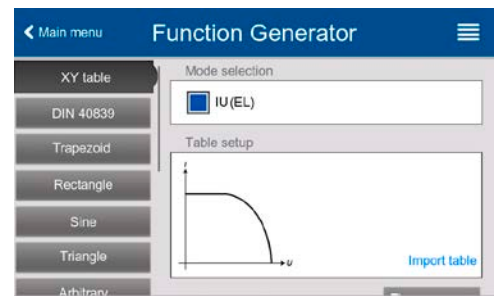

The so-called IU tables can be loaded from a file via a standard USB stick that is formatted in FAT32. In order to load the file, it has to meet following specifications:

- The file name always begins with IU (not case-sensitive)
- The file must be a text file of type Excel CSV and must only contain one column with exactly 4096 values without gaps
- Values with decimal places must use decimal separator that matches the selection in the general setting “Log file separator format”, which also defines the decimal separator between dot and comma (US default should be dot)
- No value may exceed the nominal value of the device. For example, if you have a 420 A model none of the values in the table may be higher than 420 (the adjustment limits from the device’s front panel do not apply here)
- The file(s) has/have to be put inside a folder named HMI_FILES in the root path of the stick



If these specifications are not met, the device won't accept the file and put out an error message in the display. The USB stick may contain multiple IU files with different names and list them for the selection of one.

► How to load an IU table from an USB stick:

1. While the DC input is switched off, open the function selection menu by tapping on , then select group “**XY table**”.
2. Insert the USB stick, if not already done, then tap on **Import table** and in the file selector coming up select the table you want to load and confirm with . In case the file isn't accepted for any of the above listed reasons, correct the file format and content, then try again.
3. Tap  to proceed to the next screen where you can adjust the global set values.
4. Finally proceed to the main function screen with , to start and control the function (also see “3.10.4.1. Function selection and control”).

3.10.13 Battery test function

The purpose of the battery test function is to discharge various battery types in industrial product tests or laboratory applications.

Due to the nature of an electronic it can only work in sink mode, it means only discharge the battery. In combination with a power supply, for example from series PSI 10000, a dynamic charge & discharge can be achieved, like when using the dynamic test modes of series PSB 10000. With a custom software which integrates the source and the sink device under one GUI, so they work in two-quadrant operation, any test scenario could be realized.

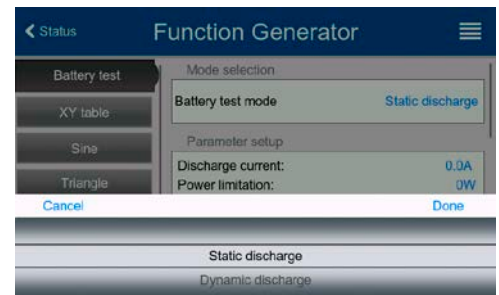

There is a choice of two modes: **Static discharge** (constant current) and **Dynamic discharge**.

In **static discharge** mode which by default runs in constant current (CC), the settings for power or resistance can also let the device run the function in constant power (CP) or constant resistance (CR). Like with the normal operation of the device the set values determine what regulation mode (CC, CP, CR) will be in effect. If, for example, CP operation is projected, the set value of current should be set to maximum and resistance mode should be turned off, so that both don't interfere. For a projected CR operation it's similar. Current and power should then be set to maximum.

For **dynamic discharge** mode there is also a power setting, but it cannot be used to run the dynamic battery test function in pulsed power mode or at least the result would not be as expected. It's recommended to always adjust the power value according to the test parameters, so it doesn't interfere with the pulsed current.

Graphical depiction of both discharging modes:

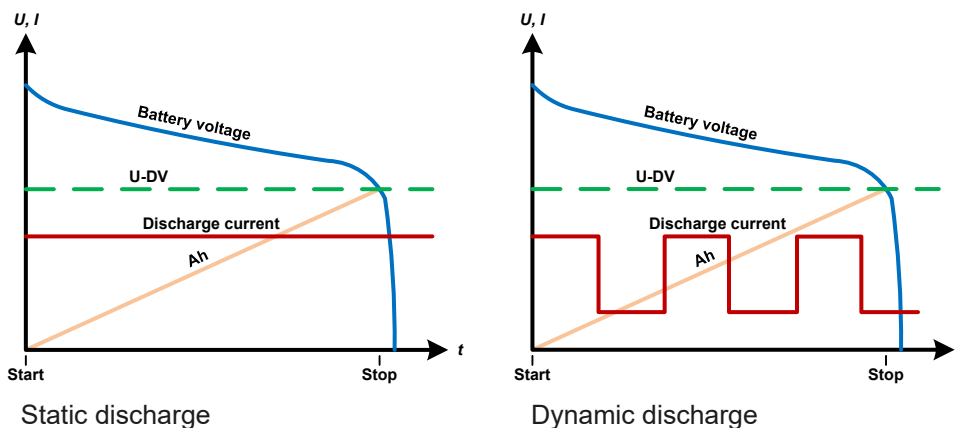

3.10.13.1 Settings for the static discharge mode

The following parameters can be configured for the static discharge battery test function:

Value	Range	Description
Discharge current	0... I_{Nom}	Maximum discharge current (in Ampere)
Power limitation	0... P_{Nom}	Maximum discharge power (in Watt)
Enable R mode	on/off	Enables the resistance mode for the test and unlocks the R value
Discharge resistance	R_{Min} .. R_{Max}	Maximum discharge resistance in Ω

3.10.13.2 Settings for the dynamic discharge mode

The following parameters can be configured for the dynamic discharge battery test function:

Value	Range	Description
Discharge current 1	0... I_{Nom}	Upper resp. lower current setting for pulsed operation (the higher value of both is automatically used as upper level)
Discharge current 2	0... I_{Nom}	
Power limitation	0... P_{Nom}	Maximum discharge power (in Watt)
Time t1	1 s ... 36000 s	t1 = Time for the upper level of the pulsed current (pulse)
Time t2	1 s ... 36000 s	t2 = Time for the lower level of the pulsed current (pause)

3.10.13.3 Stop conditions

These parameters are valid for all test modes and define additionally stop conditions:

Value	Range	Description
Discharge end voltage	0...U _{Nom}	Threshold (in Volt) to stop discharging
Action: Ah limit	None, Signal, End of test	Enables the optional stop condition
Discharge capacity	0...99999.99 Ah	Threshold for the max. capacity to consume from or feed to the battery and after which the test can stop automatically. This is optional, so that also more battery capacity can be consumed.
Action: Time limit	None, Signal, End of test	Enables the optional stop condition
Discharge time	0...10 h	Test time after which the test can stop automatically. This stop criteria is optional, it means that single tests can also run longer than 10 h.
USB logging	on/off	By setting the check mark, USB logging is enabled and will record data on a properly formatted USB stick, if plugged in the front USB port. The recorded data differs from the USB log data recorded during "normal" USB logging. See 3.10.13.5 for details.
Logging interval	100 ms - 1 s, 5 s, 10 s	Writing interval for USB logging

3.10.13.4 Displayed values

During the test run, the display will show various values and statuses:

- Actual battery voltage on the DC input
- Discharge end voltage U_{DV} (adjustable)
- Actual discharge current
- Actual power
- Consumed battery capacity
- Consumed battery energy
- Elapsed time
- Regulation mode (CC, CP, CR, CV)

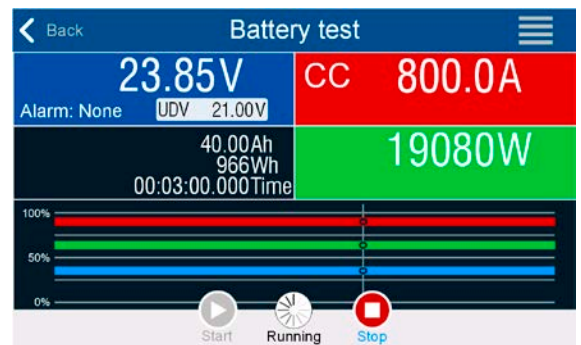

Figure 12 - Example from static discharge

3.10.13.5 Data recording (USB logging)

At the end of the configuration of all test modes there is the option to enable the USB logging feature. With an USB stick plugged and formatted as required (see 1.9.6.5), the device can record data during the test run directly to the stick and in the defined interval. Active USB logging is indicated in the display with a small diskette symbol. After the test has stopped, the recorded data will be available as text file in CSV format.

Log file format example from static discharge mode:

	A	B	C	D	E	F	G
1	Static:Uset	Iset	Pset	Rset	DV	DT	DC
2	0,00V	0,00A	1200W	OFF	0,00V	10:00:00	99999,00Ah
3							
4	Uactual	Iactual	Pactual	Ah	Wh	Time	
5	0,34V	0,00A	0W	0,00Ah	0,00Wh	00:00:00,800	
6	0,28V	0,00A	0W	0,00Ah	0,00Wh	00:00:01,800	
7	0,28V	0,00A	0W	0,00Ah	0,00Wh	00:00:02,800	
8	0,28V	0,00A	0W	0,00Ah	0,00Wh	00:00:03,800	

Static = Selected test mode
 Iset = Discharging current
 Pset = Max. power
 Rset = Desired resistance
 DV = Discharge end voltage
 DT = Discharge end time
 DC = Discharge end capacity
 U/I/Pactual = Actual values
 Ah = Consumed battery capacity
 Wh = Consumed energy
 Time = Elapsed test time



Regardless the setting for the recording interval, the values "Ah" and "Wh" are only calculated by the device once per second. When using an interval setting of < 1 s, several identical values of Ah and Wh are written into the log file.

3.10.13.6 Possible reasons for battery test stop

The battery test function run can be stopped by different reasons:

- Manual stop on the HMI with button “Stop”
- After the max. test time has been reached and action **End of test** was set for it
- After the max. battery capacity to consume has been reached and action **End of test** was set for it
- Any device alarm which would also switch off the DC input, like OT
- Reaching the threshold U_{DV} (discharge end voltage)

3.10.14 MPP tracking function

MPP stands for the maximum power point (see principle view to the right) on the power curve of solar panels. Solar inverters, when connected to such panels, constantly track this MPP once it has been found.

The device imitates this behavior in sink mode. It can be used to test even huge solar panels without having to connect a usually big solar inverter device which also requires to have a load connected to its AC output. Furthermore, all MPP tracking related parameters of the load can be adjusted and it's thus more flexible than an inverter with its limited DC input range.

For evaluation and analysis purposes, the device can also record measured data, i. e. DC input values such as actual voltage, current or power, to USB stick or provide them for reading via digital interface.

The MPP tracking function offers **four modes**. Unlike with the manual handling of other functions, values for the MPP tracking are only entered by direct input via the touch screen.

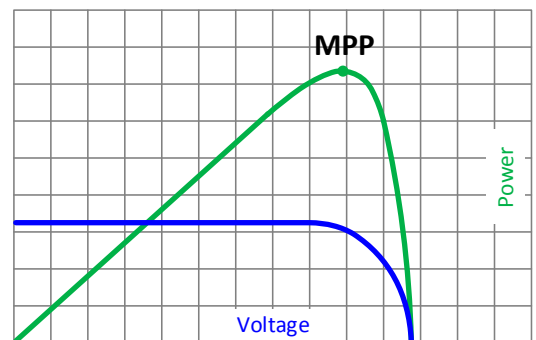
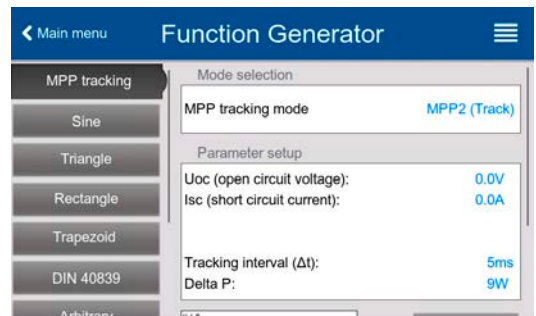

3.10.14.1 Mode MPP1

This mode is also called “**Find MPP**”. It's the simplest option to have the device find the MPP of a connected solar panel. It requires to set only three parameters. Value U_{OC} is necessary, because it helps to find the MPP quicker as if the device would start at 0 V or maximum voltage. Actually, it would start at a voltage level slightly above U_{OC} .

I_{SC} is used as an upper limit for the current, so the device would not try to draw more current than the panel is specified for. Following parameters can be configured for tracking mode **MPP1**:

Value	Range	Description
U_{OC} (open circuit voltage)	$0 \dots U_{Nom}$	Voltage of the unloaded solar panel, taken from the panel specs
I_{SC} (short-circuit current)	$0 \dots I_{Nom}$	Short-circuit current, taken from the panel specs
Tracking interval (Δt)	5 ms...60000 ms	Time between two tracking attempts when finding the MPP

Application and result:

After the three parameters have been set, the function can be started. As soon as the MPP has been found, the function will stop and switch off the DC input. The acquired MPP values of voltage (U_{MPP}), current (I_{MPP}) and power (P_{MPP}) would then be shown in the display.

The time of a function run depends on the parameter Δt . Even with the minimum setting of 5 ms one run usually takes already a few seconds.



3.10.14.2 Mode MPP2

This mode tracks the MPP, so it's closest to the operation of a real solar inverter. Once the MPP is found, the function won't stop, but try to track the MPP permanently. Due to the nature of solar panels this can only be done below the level of the MPP. As soon as this point is reached, the voltage starts to sink further and so does the actual power. The additional parameter ΔP defines how much the power may fall before the direction is reversed and the voltage starts to rise again until the load reaches the MPP. The result are zigzag shaped curves of both, voltage and current.

Typical curves are shown in the picture to the right. For the example the ΔP was set to a quite small value, so the power curve looks almost linear. With a small ΔP the load would always track close to the MPP.

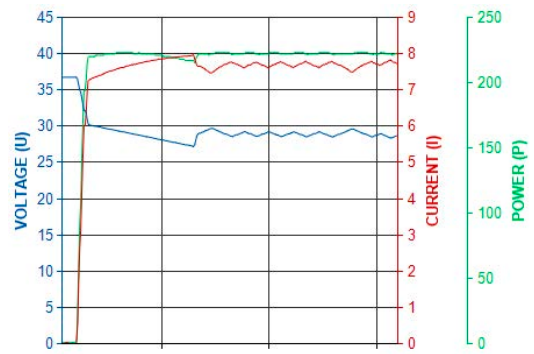

Following parameters can be configured for tracking mode **MPP2**:

Value	Range	Description
U_{OC} (open circuit voltage)	$0 \dots U_{Nom}$	Voltage of the unloaded solar panel, taken from the panel specs
I_{SC} (short-circuit current)	$0 \dots I_{Nom}$	Short-circuit current, taken from the panel specs
Tracking interval (Δt)	5 ms...60000 ms	Interval for measuring U and I during the process of finding the MPP
Delta P	$0 \dots P_{Nom}$	Tracking/regulation tolerance below the MPP

3.10.14.3 Mode MPP3

Also called "**Fast track**", this mode is very similar to mode MPP2, but without the initial step which is used to find the actual MPP, because mode MPP3 would directly jump to the power point defined by user input (U_{MPP} , P_{MPP}). In case the MPP values of the equipment under test are known, this can save a lot of time in repetitive tests. The rest of the function run is the same as with MPP2 mode. During and after the function, the least acquired MPP values of voltage (U_{MPP}), current (I_{MPP}) and power (P_{MPP}) are shown in the display.

Following parameters can be configured for tracking mode **MPP3**:

Value	Range	Description
U_{OC} (open circuit voltage)	$0 \dots U_{Nom}$	Voltage of the unloaded solar panel, taken from the panel specs
I_{SC} (short-circuit current)	$0 \dots I_{Nom}$	Short-circuit current, taken from the panel specs
U_{MPP} (max. power point)	$0 \dots U_{Nom}$	Voltage in the MPP
P_{MPP} (max. power point)	$0 \dots P_{Nom}$	Power in the MPP
Tracking interval (Δt)	5 ms...60000 ms	Interval for measuring U and I during the process of finding the MPP
Delta P	$0 \dots P_{Nom}$	Tracking/regulation tolerance below the MPP

3.10.14.4 Mode MPP4

This mode is different to the others, because it does not track automatically. It rather offers the choice to define a user curve by setting up to 100 points of voltage values, then track this curve, measure current and power and return the results in up to 100 sets of acquired data. The curve points can only be loaded from an USB stick. Start and end point can be adjusted as well, Δt defines the time between two points and the function run can be repeated up to 65535 times. Once the function stops at the end or due to manual interrupt, the DC input is switched off and the measured data is made available. After the function, the acquired set of data with the highest actual power will be shown in the display as voltage (U_{MPP}), current (I_{MPP}) and power (P_{MPP}) of the MPP. Going back on the screen with **Back** then allows for data export of the 100 measured results to USB stick.

Following parameters can be configured for tracking mode **MPP4**:

Value	Range	Description
Start	1...End	Start point for the run of x out of 100 subsequent points
End	Start...100	End point for the run of x out of 100 subsequent points
Repetitions	0...65535	Number of repetitions for the run from Start to End
Tracking interval (Δt)	5...60000 ms	Time before the next point



3.10.14.5 Load curve data from USB stick for mode MPP4

Curve point data (only one voltage value per point), in form of a CSV file, is loaded from USB stick. See section 1.9.6.5 for the naming convention. Contrary to manual adjustment where you can define and use an arbitrary number of points, loading from USB requires the CSV file to always contain the full number of points (100), because it can't define which one is start and end. However, the on-screen setting for **Start** and **End** point remain valid. It means, if you actually want to use all 100 points from your loaded curve, you must set the parameters according.

File format definition:

- The file must be a text file with appendix *.csv
- The file must contain only one column of voltage values (0... rated voltage)
- The file must exactly 100 values in 100 rows, no gaps
- The decimal separator of broken values must follow the setting "Log file separator format" where selection "US" means dot as decimal separator and selection "Standard" means comma

► How to load a curve data file for MPP4

1. While the DC input is switched off, enter the function generator by tapping on . In the selection swipe to find and tap on group **MPP Tracking**.
2. In the area "Mode selection" select **MPP4 (User curve)**. In the lower part under "Parameter" a new tap field **Load MPP4 voltage values** will appear. Tap it.
3. Insert USB stick, if not already done.
4. The next screen searches the stick for compatible files and lists them. Tap the one you want to load and confirm with .

3.10.14.6 Save result data from MPP4 mode to USB stick

After the MPP4 function has run through, the result data can be saved to USB stick. The device will always save 100 data sets consisting of the actual values of voltage, current and power belonging to the points it has run through. There is no extra numbering. In case the settings **Start** and **End** were not 1 and 100, the true result data can later be filtered from the file. Points which were not adjusted are automatically set to 0 V, thus it's very important to carefully adjust start and end point because with a voltage setting of 0 V an electronic load would draw its rated current. That's because in this mode, current and power are always set to max.

Format of the result data file (for naming convention see section 1.9.6.5):

	A	B	C
1	1,01V	20,960A	21,0W
2	2,99V	20,970A	63,0W
3	3,99V	20,970A	84,0W
4	5,99V	20,940A	125,0W
5	7,00V	20,920A	146,0W
6	8,00V	20,930A	168,0W
7	9,00V	20,950A	188,0W
8	9,99V	20,960A	210,0W
9	10,99V	20,970A	231,0W



Legend:

- Column A: actual voltage of points 1-100 (= U_{MPP})
- Column B: actual current of points 1-100 (= I_{MPP})
- Column C: actual power of points 1-100 (= P_{MPP})
- Rows 1-100: result data sets of all possible curve points



The values in the example table to the left are with physical units. If that's not wanted, they can be turned off in the "General settings" of the device with parameter "USB logging with units (V,A,W)".

► How to save a curve data file for MPP4

1. After the function has run through, it will stop automatically. Tap on **Back** to go back to the MPP4 configuration screen.
2. Insert an USB stick, if not already done.
3. Below the  button tap on **Save records**. The next screen searches the stick for compatible files and lists them. Either tap one to select it (overwrite) or don't select any file to create a new file and confirm with .

3.10.15 Remote control of the function generator

The function generator can be remotely controlled, but configuration and control of the functions with individual commands is different from manual operation. The external documentation "Programming Guide ModBus & SCPI" on the included USB stick explains the approach.

In general the following items apply:

- The function generator isn't directly controllable via the analog interface; the only impact to the function run can come from pin REM-SB switching the DC input off and on, which will also stop and restart the function
- The function generator is unavailable if R mode (resistance) is activated

3.11 Other applications

3.11.1 Parallel operation in master-slave (MS)

Multiple devices of same kind and model can be connected in parallel in order to create a system with higher total current and hence higher power. For parallel operation in master-slave mode the units are usually connected on their DC inputs, their Share bus ports and their master-slave bus ports. This bus is digital and makes the system work as one big unit regarding value adjustment, readings and all further control.

The Share bus is intended to balance the units dynamically in their voltage and also thus current on the DC input, especially if the master unit runs a dynamic function. In order for this bus to work correctly, at least the DC minus poles of all units have to be connected, because DC minus is the reference for the Share bus.

Principle view without source:

Share bus connection

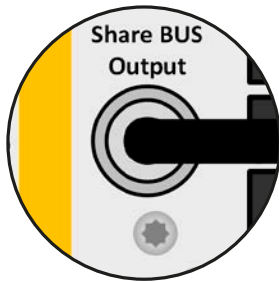

Master-slave bus

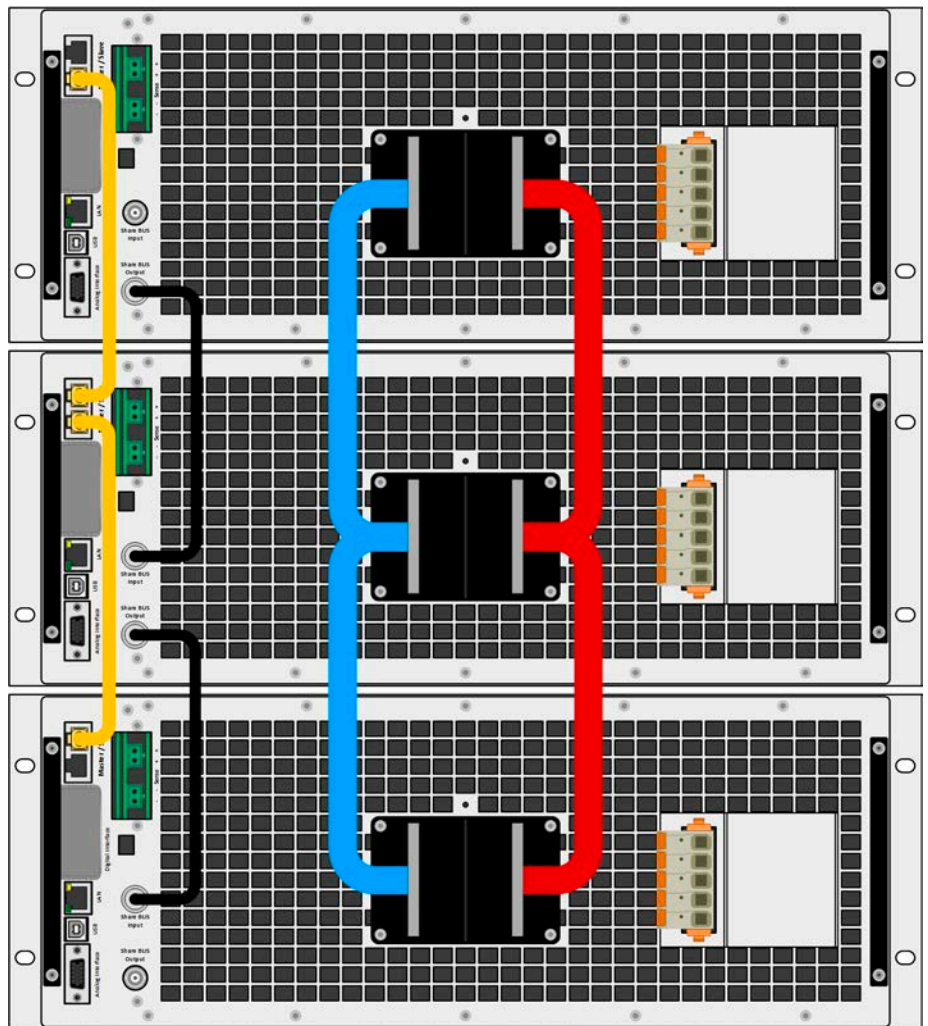

3.11.1.1 Restrictions

Compared to normal operation of a single device, master-slave operation has some *restrictions*:

- The MS system reacts partly different in alarm situations (see below in 3.11.1.7)
- Using the Share bus makes the system react as dynamic as possible, but it's still not as dynamic as single unit operation
- Connection to identical models from other series isn't supported, the master would not initialize them

3.11.1.2 Wiring the DC terminals

The DC terminal of every unit in the parallel operation is connected with correct polarity to the next unit, using cables or copper bars with a cross section according to the total system current and with short as possible length.

3.11.1.3 Wiring the Share bus

The Share bus is wired from unit to unit with standard BNC cables (coaxial, 50 Ω type) with a length of 0.5 m (1.64 ft) or similar. Both sockets are internally connected and are not specifically input or output. The labeling is only for orientation.



A max. of 64 units can be connected via Share bus.

3.11.1.4 Wiring and set-up of the digital master-slave bus

The master-slave connectors are built-in and can be connected via network cables (\geq CAT3, patch cable). After this, MS can be configured manually or by remote control. The following applies:

- A maximum of 64 units can be connected via the bus: 1 master and up to 63 slaves.
- Only devices of same kind, i.e. electronic load to electronic load, and of the same model, such as ELR 10080-1000 4U to ELR 10080-1000 4U.
- Units at the end of the bus should be terminated, if necessary (see below for more information)



The master-slave bus must not be wired using crossover cables!

Later operation of the MS system implies:

- The master unit displays, or makes available to be read by the remote controller, the sum of the actual values of all the units
- The ranges for setting the values, adjustment limits, protections (OVP etc.) and user events (UVD etc.) of the master are adapted to the total number of units. Thus, if e.g. 5 units each with a power of 30 kW are connected to a 150 kW system, then the master can be set in the range 0...150 kW.
- Slaves are no operable as long as being controlled by the master
- Slave units will show the alarm "MSP" in the display as long as they not have been initialized by the master. The same alarm is signaled after a connection drop to the master unit occurred.
- In case the function generator of the master unit is going to be used, the Share bus must be connected as well

► How to connect the digital master-slave bus

1. Switch off all units and connect the master-slave bus with network cables (CAT3 or better, cables not included). It doesn't matter which of the two master-slave sockets (RJ45, backside) is connected to the next unit.
2. Depending on the desired configuration the units are then also connected at their DC inputs. The two units at the beginning and end of the chain should be terminated, if long bus cables are in use or when bus problems occur. Termination is done with internal electronic switches which are controlled from within the Settings menu of the device in group "**Master-slave**".

They allow to separately enable the actual termination resistor (TERM) and the BIAS resistors. **Typical termination: only resistor TERM is switched on.**

In case only terminating the bus itself doesn't suffice, the BIAS resistors can be added.

Extended termination: BIAS and TERM are enabled

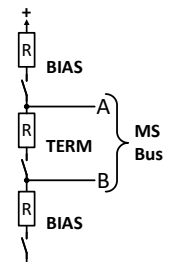

3.11.1.5 Configuring the master-slave operation

Now the master-slave system has to be configured on each unit. It's recommended to configure all the slave units first and then the master unit.

► Step 1: Configuring all slave units

1. While the DC input is switched off, tap on  in the main screen to access the **Settings** menu. Swipe up to find group "**Master-slave**" and tap it.
2. Tapping on the blue button text next to **Mode** will open a selector. By selecting **Slave**, if not already set, the master-slave mode is activated and the device is defined as slave.
3. Leave the Settings menu.



If function generator operation is setup for the master-slave system, the last step of the configuration requires to set global set values. These are important to be set to proper levels, because they are transferred to the slave units, which else would remain being set to 0 V, 0 A and 0 W.

After this, the slave is fully configured for master-slave. Repeat the procedure for all other slave units.

► Step 2: Configuring the master unit

1. While the DC terminal is switched off, tap on  in the main screen to access the **Settings** menu. Swipe up to find group **“Master-slave”** and tap it.
2. Tapping on the blue button text next to **Mode** will open a selector. By selecting **Master**, if not already set, the master-slave mode is activated and the device is defined as master.

► Step 3: Initializing the master

When setting a device to Master, the device will instantly try to initialize the MS system and the result is displayed in the very same window. In case the initialization isn't successful or the number of units or the total power is wrong, it can be repeated in this screen anytime.

Initialization state	Initialized
Number of slaves	1
System voltage	80.00V
System current	2000.0A
System power	60.00kW
System resistance	5.0000Ω
	Initialize system

Tapping **Initialize system** repeats the search for slaves in case the detected number of slaves is less than expected, the system has been reconfigured, not all slave units are already set as **Slave** or the cabling/termination is still not OK. The result window shows the number of slaves plus the total current, power and resistance of the MS system.

In case there are no slaves found at all, the master will still initialize the MS system with only itself.



As long as MS mode remains activated, the initialization process of the master-slave system will be repeated each time the master unit is powered. The initialization can also be repeated manually anytime via the Settings menu, in group “Master-Slave”.

3.11.1.6 Operating the master-slave system

After successful configuration and initialization of the master and slave units, they will show their status in the in the status area of their displays. The master would show **“MS mode: Master”** while the slave(s) would show **“MS mode: Slave”** plus **“Remote: Master-slave”**, as long they are in remote control by the master.

From now on the slaves can no longer be controlled manually or remotely, neither via the analog nor via digital interfaces. They can, if needed, be monitored via these interfaces by reading actual values and status.

The display on the master unit will reconfigure after initialization and all set values are reset. The master now displays the set and actual values of the total system. Depending on the number of units, the adjustable current and power range will multiply, while the resistance range will decrease. Then following applies:

- The system, represented by the master, can be treated like a standalone unit
- The master shares the set values etc. across the slaves and controls them
- The master is remotely controllable via the analog or digital interfaces
- All settings for the set values U, I, P and R on the master, plus also all related values from supervision, limits etc. should be adapted to the new total values
- All initialized slaves will reset any limits (U_{Min} , I_{Max} etc.), supervision thresholds (OVP, OPP etc.) and event settings (UCD, OVD etc.) to default values, so these don't interfere the control by the master. As soon as these values are modified on the master, they are transferred 1:1 to the slaves. Later, during operation, it might occur that a slave causes an alarm or an event earlier than the master, due to imbalanced current or slightly faster reaction.



In order to easily restore all these settings to what was configured before activating MS operation, it's recommended to make use of the user profiles (see “3.9. Loading and saving user profiles”)

- If one or more slaves report a device alarm, it will be signaled on the master and must be acknowledged also there. so that the slave(s) can continue their operation. Since an alarm causes the DC inputs to be switched off and can only reinstate the on/off condition automatically after PF or OT alarms, where the reaction to the alarms is configurable, action from an operator or a remote control software may become necessary.
- Loss of connection to any slave will result in shutdown of all DC inputs as a safety measure and the master will report this situation in the display with a pop-up telling “Master-slave security mode”. Then the MS system has to be re-initialized, either with or without prior re-establishment of the connection to the disconnected unit(s).
- All units, even the slaves, can be externally shut down on their DC inputs using the pin REM-SB of the analog interface. This can be used as some kind of “emergency off”, here usually a contact (maker or breaker) is wired to this pin on all units in parallel.

3.11.1.7 Alarms and other problem situations

Master-slave operation, due to the connection of multiple units and their interaction, can cause additional problem situations which do not occur when operating individual units. For such occurrences the following regulations have been defined:

- Generally, if the master loses connection to any slave, it will generate an MSP (master-slave protection) alarm, pop up a message on the screen and switch off its DC input. The slaves will fall back to single operation mode and also switch off their DC input. The MSP alarm can be deleted by initializing the master-slave system again. This can be done either in the MSP alarm pop-up screen or in the MENU of the master or via remote control. Alternatively, the alarm is also cleared by deactivating master-slave on the master unit
- If one or more slave units are cut from AC supply (power switch, blackout, supply undervoltage) and come back later, they're not automatically initialized and included again in the MS system. Then the init has to be repeated.
- If the master unit is cut from AC supply (power switch, blackout) and comes back later, the unit will automatically initialize the MS system again, finding and integrating all active slaves. In this case, MS can be restored automatically.
- If accidentally multiple or no units are defined as master the master-slave system cannot be initialized

In situations where one or multiple units generate a device alarm like OVP etc. following applies:

- Any alarm of a slave is indicated on the slave's display and on the master's display
- If multiple alarms happen simultaneously, the master only indicates the most recent one. In this case, the particular alarms can be read from the slave units displays or via digital interface by any software.
- All units in the MS system supervise their own values regarding overvoltage, overcurrent and overpower and in case of alarm they report the alarm to the master. In situations where the current is probably not balanced between the units, it can occur that one unit generates an OCP alarm though the global OCP limit of the MS system was not reached. The same can occur with the OPP alarm.

3.11.2 Series connection



Series connection of electronic loads must only be installed and operated after taking further precautionary measures! Contact us for details about the feasibility of a series connection of these devices.

4. Service and maintenance

4.1 Maintenance / cleaning

The device needs no recurring maintenance. Cleaning may be needed for the internal fans, the frequency of cleanse is depending on the ambient conditions. The fans serve to cool the components which are heated by the inherent power loss. Heavily dirt filled fans can lead to insufficient airflow and therefore the DC input would switch off too early due to overheating or possibly lead to defects.

In case there is requirement for such a maintenance, please contact us.

4.1.1 Battery replacement

The device contains a Lithium cell battery of type CR2032, which is placed on the so-called KE board which is mounted to the right-hand side wall (when looking from the front) of the device. The battery is specified for a life span of at least 5 years, but due to ambient condition, especially temperature, this span could be lower. The battery is used to buffer the internal real-time clock and if it becomes necessary to replace the battery, it can be done on location by a qualified person while maintaining typical ESD precautionary measures. The KE board would have to be loosened and lifted up carefully to access the battery.

4.2 Fault finding / diagnosis / repair

If the equipment suddenly performs in an unexpected way, which indicates a fault, or it has an obvious defect, this can't and must not be repaired by the user. Contact the supplier in case of suspicion and elicit the steps to be taken.

It will then usually be necessary to return the device to the supplier (with or without guarantee). If a return for checking or repair is to be carried out, ensure that:

- the supplier has been contacted and it's clarified how and where the equipment should be sent.
- the device is in fully assembled state and in suitable transport packaging, ideally the original packaging.
- optional extras such as an interface module is included if this is in any way connected to the problem.
- a fault description in as much detail as possible is attached.
- if shipping destination is abroad, the necessary customs papers are attached.

4.2.1 Firmware updates



Firmware updates should only be installed when they can eliminate existing bugs in the firmware in the device or contain new features.

The firmware of the control panel (HMI), of the communication unit (KE) and the digital controller (DR), if necessary, is updated via the rear side USB port. For this the software EPS Power Control is needed which is included with the device or available as download from our website together with the firmware update, or upon request.

However, be advised not to install updates promptly. Every update includes the risk of an inoperable device or system. We recommend to install updates only if...

- an imminent problem with your device can directly be solved, especially if we suggested to install an update during a support case
- a new feature has been added which you definitely want to use. In this case, the full responsibility is transferred to you.

Following also applies in connection with firmware updates:

- Simple changes in firmwares can have crucial effects on the application the devices are use in. We thus recommend to study the list of changes in the firmware history very thoroughly.
- Newly implemented features may require an updated documentation (user manual and/or programming guide, as well as LabVIEW VIs), which is often delivered only later, sometimes significantly later

4.3 Calibration

4.3.1 Preface

The devices of series ELR 10000 don't have a built-in feature to re-adjust the most important DC input related values, but they can still be readjusted using the software EPS Power Control. The required calibration app is included in the free of charge base version of this software. In order to use the feature it may be necessary to install a new update of this software.

Re-adjustment is intended to compensate small deviations of the output related values of voltage and current in a range of up to 1% or 2% of the rated value. There are several reasons which could make it necessary to re-adjust a unit: component aging, component deterioration, extreme ambient conditions, high frequent use.

In order to determine if a value is out of tolerance, the parameter must first be verified with measurement tools of high accuracy and with at least half the error of the PSB device. Only then a comparison between values displayed on the PSB device and true DC output/input values is possible.

For example, if you want to verify and possibly readjust the output current of model ELR 10080-1000 4U which has 1000 A maximum current, stated with a max. error of 0.1%, you can only do that by using a high current shunt or current transducer with max. 0.05% error or less. Also, when measuring such high currents, it's recommended to keep the process short, in order to avoid the shunt heating up too much. It's furthermore recommended to use a shunt with at least 25% reserve.

When measuring the current with a shunt, the measurement error of the multimeter on the shunt adds to the error of the shunt and the sum of both must not exceed the max. error of the device under calibration.

4.3.2 Preparation

For a successful calibration and readjustment, a few tools and certain ambient conditions are required:

- A measurement device (multimeter) for voltage, with a max. error of half the ELR's voltage error. That measurement device can also be used to measure the shunt voltage when readjusting the current
- If the current is also going to be calibrated: a suitable DC current shunt or transducer, ideally specified for at least 1.25 times the max. current rating of the ELR and with a max. error that is half or less than the max. current error of the ELR device to calibrate
- Normal ambient temperature of approx. 20-25°C
- One or two adjustable sources which are capable of supplying at least 102% of the max. voltage and current of the ELR device and which are calibrated and precise

Before you can start calibrating, a few measures have to be taken:

- Let the ELR device warm up for at least 10 minutes under 50% load, in connection with the voltage / current source
- In case the remote sensing input is going to be calibrated, prepare a cable for the remote sensing connector to the DC input, but leave it yet unconnected
- Abort any form of remote control, deactivate master-slave mode, deactivate resistance mode
- Install the shunt or transducer between the ELR device and the source and make sure the shunt/transducer is cooled somehow
- Connect external measurement devices to the DC input and/or to the shunt/transducer, depending on whether the voltage is going to be calibrated first or the current

4.3.3 Calibration procedure

The re-adjustment is done in the graphical user interface of EPS Power Control. The software will guide through the process with instructions, as far as possible. The user manual of the software holds additional information.

5. Contact and support

5.1 General

Repairs, if not otherwise arranged between supplier and customer, will be carried out by the manufacturer. For this the device must generally be returned to the manufacturer. No RMA number is needed. It's sufficient to package the equipment adequately and send it, together with a detailed description of the fault and, if still under guarantee, a copy of the invoice, to the following address.

5.2 Contact options

Questions or problems with operation of the device, use of optional components, with the documentation or software, can be addressed to technical support either by telephone or e-Mail.

Headquarter	e-Mail	Telephone
EPS Stromversorgung GmbH Alter Postweg 101 86159 Augsburg Germany	All topics: info@eps-germany.de	Switchboard: +49 821 / 570451-0

