



EPS - Datasheet

Series EPS/ELR 10000 3U

EPS's programmable Electronic Loads »EPS/ELR 10000 3U« series are especially suitable for test systems and industrial controls due to their compact construction of a 19" enclosure (3U). The DC input range features new voltages up to 2000V, currents up to 510A at power ratings with 15kW (derating at 208VAC 3ph 3/6/9kW)).

The devices of series EPS/ELR 10000 are energy recovering, switching electronic loads. The recovery of recuperation feature inverts the consumed DC energy with an efficiency of up to 95,5% and feeds it back into the local mains. In common system, the energy from burn-in tests and battery capacity tests is radiated into the environment. This energy can be recovered with this unit. In the battery test mode, even a battery can be discharged with a constant current, - power or - resistance until the battery voltage reaches an adjustable final discharge voltage. If this threshold is exceeded, the load input is automatically switched off (deep discharge protection). The discharge time and consumed charge (Ah) are measured and displayed on a 5" TFT or alternatively recorded on a USB stick.

Apart from basic functions of electronic loads, set point curves can be generated by the integrated function generator (sine, rectangular, triangular and other curves types). Arbitrary generator curves (up to 99 points) can be saved to and loaded from an USB stick. For industrial component testing, the devices furthermore offer a battery test and an MPP tracking function for solar module tests.

For remote control the devices are provided as standard with USB and Ethernet ports on the rear side, as well as a galvanically isolated analog interface. Via optional plug-in interface modules, another digital interface such as for RS232, Profibus, ProfiNet, ModBus TCP, CAN, CANopen or EtherCAT can be added. These enable the devices to be connected to standard industrial buses simply by changing or adding a small module. The configuration, if necessary at all, is simple.

In addition, the devices offer as standard the possibility for parallel connection in so-called Share bus operation for constant current sharing, plus a true master-slave connection with totaling of all actual values is also provided as standard. Using this operating mode, up to 64 devices can be connected to form a system that offers an increased total output of up to 960 kW.

Further options are a grid and system protection, extended warranty, calibration with protocol as well as 19" racks.

The devices are CE, UL as well as CSA certified.

Energy Efficiency: Energy recovery, high efficiency, temperature regulated fans

Scope of delivery:

EI. Load Recovery

Test report

AC connector plug (clamp type)

2x Plug for Remote Sense

Set DC terminal cover

Terminal cover sense

Cable tie for strain relief

USB cable 1,8m

USB-Stick with documentation and Software

EPS/ELR 10360-120 3U Electronic Load with mains backfeed

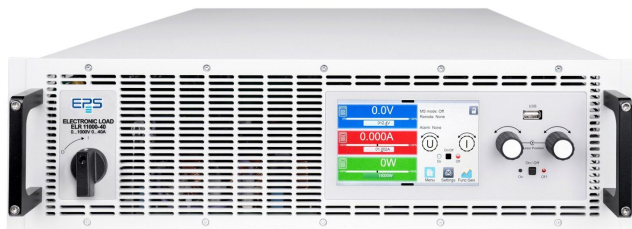

EPS/ELR 10000_3U_front

General data

Behavior	Unidirectional
Technology	Switching
Operation modes	CC.CV.CP.CR
Mains	380V/400V/480V AC +-10% 3ph., 208V derat. 9 kW
Input frequency	45-66Hz
Power factor	>0,99
Input Current Limitation	Standard
Power feed back	Standard
Display	TFT Touch Panel 5"
Voltage resolution	0,01 V
Voltage accuracy	<0,05%
Voltage Stability Load	<=0,02% fs
Voltage Stability Mains	<0,01% fs
Response time Voltage	<0,05% fs (0-100%)
Current Resolution	0,1 A
Current Accuracy	<=0,1% fs
Current Stability Load	<=0,2% fs
Current Stability Mains	<0,01% fs
Rise time Current	<=10ms (10-90%)
Response time Current	<=0,1% fs (0-100%)
Power Accuracy	<1,0% Pnom
Internal Resistance Regulation	Standard
Overheat protection	Standard
Isolation In-/Output	3750 Vrms
Isolation Output/Enclosure	neg.+1000VDC, Pos.+1000VDC max.

Series EPS/ELR 10000 3U

Parallel operation	Standard
Current sharing	Standard (M/S)
Cooling	Fan
Operation temperature	0-50°C
Storage temperature	-20...70°C
Humidity	<80% n.c
Attitude	2000m /NN
Design	19 inch
Standards	EN/UL/CSA-C22.2 61010-1,EN55011 cl.B,EN61326-1
Power fail	Standard
Alarmmanagement	Standard
Function generator	+arbitrary
Memory	5 Profile
Capacity	1179µF

Interfaces

Analog Isolation	Standard (intern)
Accuracy Interface	0-10V <= 0.1%; 0-5V <=0.2%
Remote Control	U / I / P
Input Signal	Intern/extern,Input on/off,R mode
USB Interface	Standard
RS232 Interface	Option EPS/IF-AB R
CAN Interface	Opt.EPS/IF-AB-Co/CAN
Profibus	Option EPS/IF-AB-PB
Ethernet Interface	Standard, Opt.IF-ETH1P/2P
Ethercat Interface	Option EPS/IF-AB-ECT
Software	Standard EPS/PC, Option EPS/MC

Technical data

Input Power	0-15000W
Input Voltage	0-360 VDC
Input Current	0-120 A
Efficiency	<=95,5%
Ripple U	320 mVpp(20Mhz)/55 mVrms(300k)
Resistance Adjustment Range 1	0,1-180 Ohm
Resistance Resolution Range 1	0,001 Ohm
Remote Sensing	Standard
Dimensions in mm (WxHxD)	483 x 133 x 668
Weight	32,8 kg
Order code	300299

Options

Option 1	Mains monitoring module EPS/ELR ENS (BISI)
Option 2	Extended Warranty 2 / 3 / 5 years EPS/G2/3/5
Option 3	Modbus Interface 2 EPS/IF-AB MB2P
Option 4	Calibration with protocoll EPS/ELR CAL

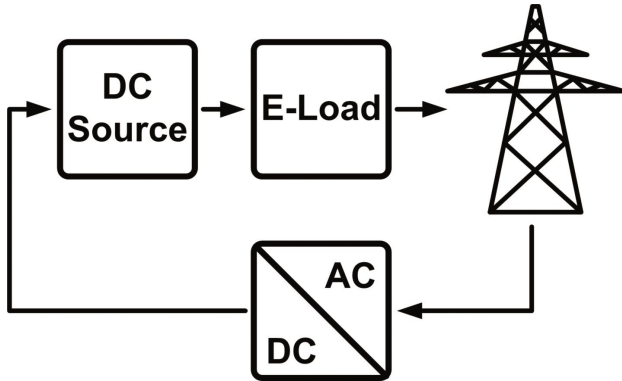

EPS/ELR_graphics_backfeed

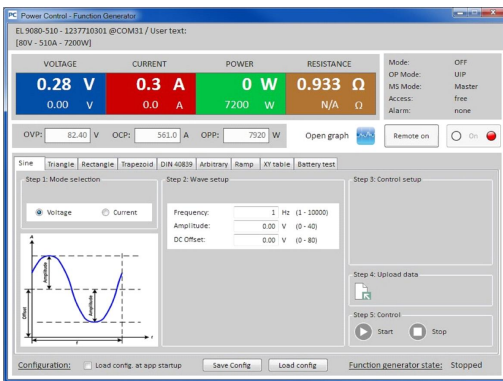

EPS/PC Software_en

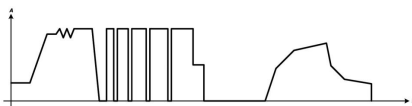

FG Beispiel-Example XY Generator

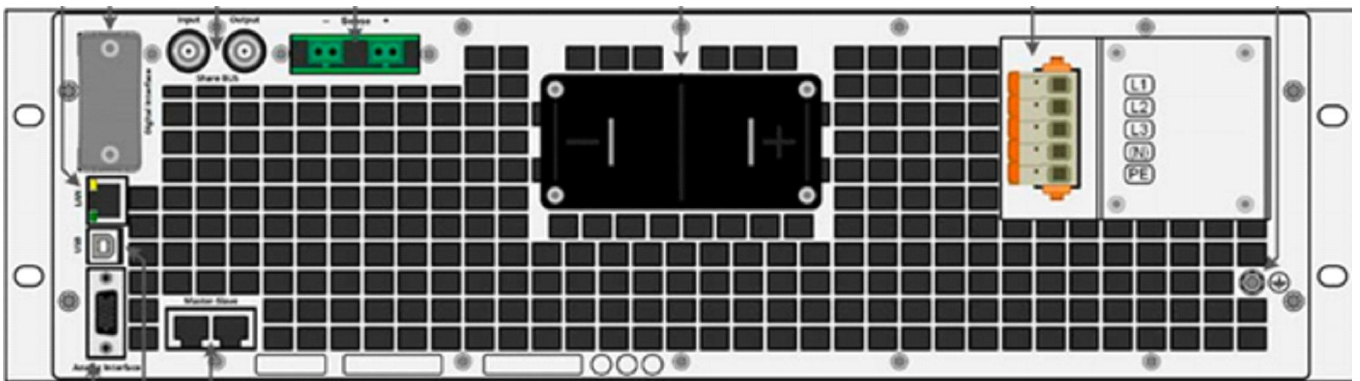

EPS_10000 rear

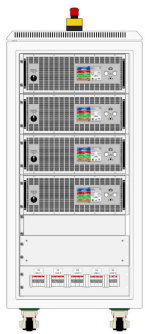

EPS_Cabinet front example 120kW

Subject to modification without notice, errors and omissions excepted

EPS Stromversorgung GmbH
Electronic Power Supplies
Alter Postweg 101, 86159 Augsburg/Germany
Tel.: +49 (0) 821 570451-0
E-mail: sales@eps-germany.de
www.eps-germany.de